

**Stocco**  
F.lli srl



MADE IN ITALY

[www.stoccofratelli.eu](http://www.stoccofratelli.eu)

LAVORAZIONE DEL FERRO  
ELEMENTI PER L'ARREDO

METAL WORK  
FURNITURE COMPONENTS







CATALOGO GENERALE  
GENERAL CATALOGUE

2024



CATALOGO  
INDOOR



CATALOGO  
OUTDOOR



CATALOGO  
LIBRERIA D.13



## UNITA' 2 – Via XXIX Aprile 1

La Stocco F.lli è nata nel 1984 come azienda terzista a conduzione familiare.

Ha iniziato l'attività occupandosi di montaggio e piegatura di prodotti metallici per la casa e il tempo libero. Successivamente, seguendo l'evoluzione del mercato, si è specializzata con successo nella produzione di telai ed elementi d'arredo, per lo più in ferro, ma lavora anche materiali quali Inox e alluminio.

Negli ultimi anni l'acquisizione di attrezzature ad alta tecnologia e produttività ha permesso di proporre una serie di prodotti nuovi, facendo della versatilità produttiva e della qualità costante il punto di forza della Stocco F.lli. Sono stati inoltre introdotte modalità di esecuzione e materiali che aiutano l'economia circolare.

L'azienda offre al cliente non solo un prodotto, ma un intero servizio, che coniuga esigenze qualitative, quantitative, design e tempistica a prezzi competitivi.

Attualmente l'attività si svolge su tre unità operative diverse ma vicine (produzione di elementi in tubo / produzione di elementi in trafilato e lamiera / magazzino di imballo e logistica), per un totale di oltre 10.500 mq coperti e altri 15.000 mq scoperti.

Per la lavorazione si parte dal tubo grezzo con diametro di max 150 mm o dal trafilato (da d.4 mm a 14 mm) o dalla lamiera da 0,5 a 25 mm.

L'elemento viene tagliato a Laser, piegato, stampato (tutto con macchine a controllo numerico) e i particolari ottenuti vengono assemblati con l'ausilio di robot antropomorfi per saldature a MIG.

E' stato acquistato anche un robot Cobot per le tirature basse come pure un robot di puntatura a proiezione di grandi dimensioni per trafilato fino a d.12 mm .

Possono essere anche eseguite saldature a TIG e castolin.

La fase finale prevede finiture come pulitura, cromatura, doratura, verniciatura, cataforesi, zincatura, tutte operazioni fatte esternamente da fidati collaboratori.

Montaggio (di eventuali legni, imbottiture, intrecci, plastiche, etc) , stoccaggio e spedizione completano il ciclo.

In questi anni la Stocco f.lli ha prodotto telai e particolari d'arredo in esclusiva e non per rinomate aziende del settore, sia nazionali che estere per milioni di pezzi; attualmente il mercato è sviluppato in 18 paesi del mondo.

La presenza costante dei soci e la disponibilità del team, che da sempre contraddistinguono la ditta, permettono di offrire al cliente risposte affidabili e certe.



*Stocco F.lli was founded in 1984 as a family-run company that worked for third parts.*

*It started the business dealing with assembly and bending of metal products for home and leisure. Successively, following the evolution of the market, it has successfully specialized in the production of frames and furnishing elements, mostly made of iron, but it also works materials such as stainless steel and aluminium.*

*In recent years, the acquisition of high-tech and productivity equipment has made it possible to propose a series of new products, making production versatility and constant quality the strong point of Stocco F.lli. Execution methods and materials that help the circular economy have also been introduced.*

*The company offers the customer not only a product, but an entire service, which combines qualitative, quantitative, design and timing requirements at competitive prices.*

*Currently the activity takes place on three different but close operating units (production of pipe elements / production of drawn and sheet metal elements / packaging and logistics warehouse), for a total of over 10,500 covered square meters and other 15,000 uncovered square meters.*

*For the processing, it starts from the raw tube with a diameter of max 150 mm or from the drawn (d.4 mm to 14 mm) or the sheet metal from 0.5 to 25 mm.*

*The element is laser cut, bent, printed (all with numerical control machines) and the obtained parts are assembled with the help of anthropomorphic robots for MIG welding.*

*A Cobot robot was also purchased for short runs as well as a large projection-type robot for drawn products up to d.12 mm.*

*TIG and castolin welds can also be performed.*

*The final phase includes finishes such as polishing, chroming, gilding, painting, cataphoresis, galvanizing, all operations done externally by trusted partners.*

*Assembly (wood, pads, weave, plastics, etc.) , storage and shipping complete the cycle.*

*During these years, Stocco F.lli has produced frames and furnishing details exclusively and non-exclusively for renowned companies in the sector, both national and foreign, for millions of pieces; currently the market is developed in 18 countries around the world. The constant presence of the partners and the availability of the team, which have always distinguished the company, allow it to offer the customer reliable and certain answers.*

# INDICE INDEX

## SEDIE CHAIRS



✓ FENICE  
p. 12



✓ ISCHIA  
p. 14



✓ SCALA SLITTA  
p. 15



✓ SCALA 4 GAMBE  
p. 16



✓ NICOLESS  
p. 18



✓ KATE  
p. 20



✓ KATHRINE  
p. 21



✓ TUNISI  
p. 22



✓ TROPEA  
p. 23



✓ TROPEA WOOD  
p. 24



✓ SALLY  
p. 26



✓ SALLY WOOD  
p. 27



✓ CESENA  
p. 28



✓ CESENA CON BRACCIOLI  
p. 29



✓ ALMA  
p. 30



✓ RED BONDED  
p. 32



✓ FARGO  
p. 33



✓ ASTRAL  
p. 34



✓ QUEBEC  
p. 35



✓ VENEZIA  
p. 36



✓ MALAGA  
p. 38



✓ MARANO 4G  
p. 39



✓ CONFORT - ISO  
p. 40



✓ TOP  
p. 41



✓ SCHOOL  
p. 42

## SGABELLI STOOLS



✓ SEDUTE  
p. 44



✓ NICOLINO  
p. 46

# INDICE INDEX



CESENA  
p. 47



SLOT76  
p. 59



ARIZONA  
p. 70



FELIX  
p. 48



DETROIT  
p. 60



GEORGIA  
p. 71



PISA REGOLABILE  
p. 50



VENEZIA  
p. 61



MORGAN  
p. 72



PISA  
p. 52



MALAGA S  
p. 62



MORGAN 4G  
p. 73



RIO  
p. 53



ALMA S  
p. 63



MORGAN GIREVOLE  
p. 74



MILTON  
p. 54



TROPEA WOOD  
p. 64



SILLA  
p. 75



PERUGIA  
p. 55

POLTRONE /  
ATTESA  
ARMCHAIRS /  
WAITING ROOM  
CHAIRS



BERNA  
p. 76



PILLO  
p. 56



COLLODI  
p. 67



TOLEDO / TOLEDO D  
p. 77



PANAMA  
p. 57

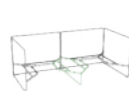

ALOE  
p. 68

PANCHE  
BENCHES



TORONTO  
p. 58



ALOE D  
p. 69



CUBA  
p. 79

# INDICE INDEX



UNIVERSALE  
p. 80

TAVOLI  
TABLES



PIANI  
p. 83



GIGLIO  
p. 84



ABUNDANTIA TONDO  
p. 86



ABUNDANTIA OVALE  
p. 88



PLAZA  
p. 90



CRETA  
p. 92



ITACA  
p. 93



CORFU  
p. 94



ZANTE  
p. 95



CLASS40  
p. 96



CLASS  
p. 98



APOLLO  
p. 99



BABYLON  
p. 100



RIGA  
p. 102



RODI  
p. 103



TROPEA WOOD  
p. 104



HIDE / HIDE Q  
p. 105



BURANO  
p. 106



PISA T  
p. 107



ATLANTA QUADRO  
p. 108



ATLANTA TONDO  
p. 109



ATLANTA QR  
p. 110

TAVOLINI  
COFFEE  
TABLES



ELEGANT  
p. 112



PARVUS 800  
p. 114



PARVUS 500  
p. 116



CRUZ  
p. 118



# INDICE INDEX



▣ TULUM  
p. 119



▣ HAWAII  
p. 120



▣ ZANZIBAR  
p. 122



▣ MALINDI  
p. 123



▣ MAYA  
p. 124

## LIBRERIE BOOKCASES



▣ D.13  
p. 126



▣ CUBA  
p. 127

## COMPLEMENTI D'ARREDO ACCESSORIES



▣ CAMILLO  
p. 129



▣ TIPI  
p. 130



▣ EGO  
p. 132



▣ CARRELLO HIDE  
TROLLEY HIDE  
p. 133



▣ CARRELLO PLUS  
TROLLEY PLUS  
p. 134



▣ CARRELLO MACISTE  
TROLLEY MACISTE  
p. 135



▣ PORTAOMBRELLI BETA  
UMBRELLA STANDS BETA  
p. 136



▣ PORTAOMBRELLI GAMMA  
UMBRELLA STANDS GAMMA  
p. 137

## COMPONENTI COMPONENTS



▣ BASI  
BASES  
p. 139



▣ COLONNE  
COLUMNS  
p. 144



▣ ALZATE A GAS  
GAS LIFTS  
p. 146



▣ ATTACCHI PIASTRE  
JOINTS PLATES  
p. 147



▣ BRACCIOLI  
ARMRESTS  
p. 151



▣ POGGIAPIEDI VALENCIA  
FOOTREST VALENCIA  
p. 152



▣ GAMBA UNIVERSAL  
CONIC LEG UNIVERSAL  
p. 152



▣ REGGIMENSOLA  
SHELF SUPPORT  
p. 152



▣ ANELLI ADATTATORI  
ADAPTOR RINGS  
p. 153



▣ HOSTAFORM  
HOSTAFORM  
p. 153



▣ FELTRINI  
FELTS  
p. 153



▣ RUOTE  
WHEELS  
p. 154

*“Le idee più complesse  
hanno soluzioni semplici”*

*“The most complex ideas  
have simple solutions”*

SEDIE  
*CHAIRS*



# Fenice

Telaio a 4 gambe  
In tubo d.16x2 mm e tondini d.11 mm  
e d.6 mm  
Con cuscino seduta in ecopelle  
Impilabile

## Finiture

Telaio verniciato  
Cuscino in ecopelle colore nero , grigio  
scuro, tortora o su richiesta



## Misure

H. 860 mm  
P. 540 mm  
L. 460 mm

*Frame with 4 legs  
In tube d.16x2 and wires d.11 mm and  
d.6 mm  
With friendly-leather PVC cushion  
Stackable*

## Finishing

*Painted frame  
Friendly-leather PVC cushion in black,  
dark grey, dove grey or other on demand*



## Measures

*H. 860 mm  
P. 540 mm  
L. 460 mm*



# Ischia

Telaio con gambe in legno  
Scocca in foto:  
Florida senza braccioli in poliuretano  
rivestito in tessuto

## **Finiture**

Gambe in legno faggio naturale o tinto  
noce  
Tessuto su richiesta , antimacchia,  
idrorepellente, antibatterico e anallergico

## **Optional**

Scocca con o senza braccioli  
Altre scocche su richiesta  
Versione girevole, fissa o con  
autoallineante

## **Misure**

H. 840 mm  
P. 430 mm  
L. 560 mm

*Frame with wooden legs  
Shell in the picture:  
Florida without armrests in polyurethane,  
upholstered with fabric*

## **Finishing**

*Wooden legs in natural beech or painted  
in nut colour  
Fabric on demand, with treatment  
against stains, water repellent, anti-  
bacterial, hypoallergenic*

## **Optional**

*Shell with or without armrests  
Other shells on demand  
Swivel version, fixed version or with  
self-turning mechanism version*

## **Measures**

*H. 840 mm  
P. 430 mm  
L. 560 mm*



# Scala Slitta

Telaio slitta  
In tubo d.25x2 Asform

## Finiture

Telaio cromato o verniciato nero ral 9005 / bianco ral 9003 opaco liscio  
Telaio ai sali di zinco e vernice per esterno

## Optional

Scocca mod. Gemma o Gardenia in plastica bianca - grigia - taupe - antracite



Scocca in plastica mod. Gemma o Gardenia rivestita in tessuto Velvet, colori beige - ottanio - grigio o taupe per quantitativi



Impilabile 3 pezzi con scocca montata

## Misure

H. telaio 423 mm  
P. 561 mm  
L. 498 mm

Frame cantilever  
In tube d.25x2 Asform

## Finishing

Chromed frame or painted frame in black ral 9005 / white ral 9003 matt and smooth  
Frame with zinco powder and outdoor painting

## Optional

Upholstered plastic shell mod. Gemma or Gardenia, white - grey - taupe - charcoal grey



Upholstered plastic shell mod. Gemma or Gardenia with Velvet fabric, in colours: beige - octane - grey or taupe, for quantities



Stackable 3 pcs with assembled shell

## Measures

H. frame 423 mm  
P. 561 mm  
L. 498 mm



Con scocca Gemma bianca  
With shell Gemma white



Con scocca Gardenia nera  
With shell Gardenia black





# Scala 4 Gambe

Telaio 4 gambe  
In tubo d.20x1.5 ferro normale

## Finiture

Telaio cromato o verniciato nero ral 9005 / bianco ral 9003 opaco liscio  
Telaio ai sali di zinco e vernice per esterno

## Optional

Scocca mod. Gemma o Gardenia in plastica bianca – grigia – taupe – antracite



Scocca in plastica mod. Gemma o Gardenia rivestita in tessuto Velvet, colori beige – ottanio – grigio o taupe per quantitativi



## Misure

H. telaio 430 mm  
P. 528 mm  
L. 453 mm

Frame 4 legs  
In tube d.20x1.5 normal iron

## Finishing

Chromed frame or painted frame in black ral 9005 / white ral 9003 matt and smooth  
Frame with zinco powder and outdoor painting

## Optional

Plastic shell mod. Gemma or Gardenia, white – grey – taupe – charcoal grey



Upholstered plastic shell mod. Gemma or Gardenia with Velvet fabric, in colours: beige – octane – grey or taupe, for quantities



## Measures

H. frame 430 mm  
P. 528 mm  
L. 453 mm



Con scocca Gardenia  
With shell Gardenia



Con scocca Gemma  
With shell Gemma



# Nicoless



Telaio in tondino d.12 mm con fascette autobloccanti per la scocca  
Impilabile  
Scocca in feltro con materiale al 100% RICICLATO  
(70% di bottiglie di plastica riciclata, 30% residui di cotone)

## Finiture

Telaio verniciato nero ral 9005 goffrato opaco  
Telaio verniciato bianco ral 9003 goffrato opaco  
Altre verniciature su richiesta  
Scocca in feltro grigio scuro o grigio chiaro

## Optional

Cuscino in 3d in tessuto DAMA 100% lana riciclata  
Colori disponibili : Blu 0048 - Rosso 058 - Grigio chiaro 0057 - Verde 0064 - Grigio scuro 0002



Carrello portasedie mod. Maciste

## Misure

H. 585 mm  
P. 499 mm  
L. 590 mm

*Frame in wire d.12 mm with self-blocking strips for the shell*  
*Stackable*  
*Shell made of felt 100% RECYCLED (70% of recycled PET bottles, 30% cotton residue)*

## Finishing

*Black painted frame ral 9005 embossed*  
*White painted frame ral 9003 embossed*  
*Other colours on demand*  
*Felt shell in dark grey or light grey colour*

## Optional

*3d cushion in 100% recycled wool*  
*DAMA fabric*  
*Available colours: Blue 0048 – Red 058 – Light grey 0057 – Green 0064 – Dark grey 0002*



*Chair trolley mod. Maciste*

## Measures

*H. 585 mm*  
*P. 499 mm*  
*L. 590 mm*



reddot award 2016  
winner



Green  
Product Award  
Winner 2018



DESIGNEUROPA  
awards 2018  
finalist

Stocco



# Kate

Scocca in polipropilene  
Telaio TROPEA K WOOD con gambe in legno  
Telaio TROPEA K d.11 mm con piedini snodati  
Base ELBA K a 4 razze, girevole

## Finiture

Telaio/base cromato o verniciato  
Gambe in legno faggio naturale / tinto noce o frassino naturale  
Scocca in polipropilene bianco / nero

## Misure

Da definire a seconda della base/telaio scelto

*Polypropylene shell  
Frame TROPEA K WOOD with wooden legs  
Frame TROPEA K d.11 mm with adjustable glides  
Base ELBA K, 4 legs, swivel*

## Finishing

*Chromed or painted frame/base  
Wooden legs in natural beechwood / walnut painted beechwood / natural ashwood  
Polypropylene shell in black or white*

## Measures

*To be defined according to the chosen base/frame*



Con base Elba K / With base Elba K



Con telaio Tropea K Wood / With frame Tropea K Wood



Con telaio Tropea K / With frame Tropea K

# Kathrine

Scocca in polipropilene  
Telaio TROPEA K d.11 mm con piedini  
snodati  
Telaio TROPEA K WOOD con gambe in  
legno  
Base ELBA K a 4 razze, girevole

## Finiture

Telaio/base cromato o verniciato  
Gambe in legno faggio naturale / tinto  
noce o frassino naturale  
Scocca in polipropilene bianco o nero

## Misure

Da definire a seconda della base/telaio  
scelto

*Polypropylene shell  
Frame TROPEA K d.11 mm with  
adjustable glides  
Frame TROPEA K WOOD with wooden  
legs  
Base ELBA K with 4 legs, swivel*

## Finishing

*Chromed or painted frame/base  
Wooden legs in natural beechwood /  
walnut painted beechwood / natural  
ashwood  
Polypropylene shell, white or black*

## Measures

*To be defined according to the chosen  
base/frame*



Con telaio Tropea K Wood / With frame Tropea K Wood



Con telaio Tropea K / With frame Tropea K



Con base Elba K / With base Elba K

# Tunisi

Telaio in tondino Ø 11 mm  
Impilabile

**Finiture**  
Cromato  
Verniciato

**Optional**  
Seduta in legno mod. ASTRAL in faggio  
verniciato naturale o tinto wengh 

**Misure**  
H seduta 450 mm  
P 537 mm  
L 450 mm

*Frame in wire Ø 11  
Stackable*

**Finishing**  
*Chromed  
Painted*

**Optional**  
*Wooden seat mod. ASTRAL in natural  
beechwood or painted in wengh  colour*

**Measures**  
*H seat 450 mm  
P 537 mm  
L 450 mm*



# Tropea

Telaio in trafilato Ø 11 mm pieno  
Non impilabile

## Finiture

Verniciato  
Cromato

## Optional

Telaio con o senza piedini snodati  
Scocca in legno mod. Venezia / Quebec  
Scocca mod. Florida rivestita in tessuto  
con o senza braccioli

## Misure

H 425 mm telaio  
P 450 mm telaio  
L 420 mm telaio

Frame wire Ø 11 mm  
Not stackable

## Finishing

Painted  
Chromed

## Optional

Frame with or without adjustable glides  
Wooden seat mod. Venezia / Quebec  
Upholstered shell mod. Florida with or  
without armrests

## Measures

H 425 mm frame  
P 450 mm frame  
L 420 mm frame



Con scocca Venezia / With shell Venezia



Con scocca Florida / With shell Florida with armrests

Adatta per / Suitable for:  
Scocca Florida senza braccioli  
Shell Florida without armrests



Scocca Quebec  
Shell Quebec







# Tropea Wood

Telaio in trafilato d.11 mm  
Non impilabile  
Con gambe in legno alte o basse

## Finiture

Telaio cromato o verniciato  
Gambe in legno faggio naturale / tinto  
noce / frassino naturale

## Optional

Scocca in legno mod. Venezia/Quebec  
o rivestita  
Scocca Florida con o senza braccioli  
rivestita in tessuto

## Misure

H 426 mm  
L 455 mm  
P 492 mm

*Frame d.11 mm  
Not stackable  
With high or low wooden legs*

## Finishing

*Chromed or painted frame  
Wooden legs in natural beech / painted  
in walnut colour / natural ash*

## Optional

*Wooden seat mod. Venezia/Quebec or  
upholstered  
Shell Florida with or without armrests  
upholstered with fabric*

## Measures

*H 426 mm  
L 455 mm  
P 492 mm*



Con scocca Venezia / With shell Venezia



Adatta per / Suitable for:  
Con scocca Florida  
With shell Florida with armrests



# Sally

Telaio in tubo d.28x1.5 mm conificato  
Con scocca in gomma rivestita in tessuto

## Finiture

Telaio verniciato grigio ral 7021 goffrato  
Scocca singola in poliuretano da taglio bianco da rivestire o rivestita in tessuto

## Optional

Scocca singola con o senza braccioli mod. SALLY  
Solo telaio SALLY in ferro  
Base a scelta come mod. ELBA / BURANO

## Misure

H 408 mm telaio  
P 440 mm telaio  
L 450 mm telaio

*Frame in tube d.28x1.5 mm conic  
With foam shell, upholstered with fabric*

## Finishing

*Painted frame in grey ral 7021 embossed  
Shell in white cut polyurethane to be upholstered or upholstered with fabric*

## Optional

*Single shell with or without armrests mod. SALLY  
Only metal frame SALLY  
Base on customer's demand as mod. ELBA / BURANO*

## Chair Measures

*H 408 mm frame  
P 440 mm frame  
L 450 mm frame*



Con scocca Sally con braccioli  
With shell Sally with armrests



Con base Burano / With base Burano

Adatto alle basi / Suitable for the bases:



Base Burano



Base Elba

# Sally wood

Telaio SALLY WOOD con gambe in legno coniche e semiovali  
Con scocca in gomma rivestita in tessuto

## Finiture

Telaio con piastra verniciata  
Gambe in legno faggio verniciato noce o verniciato naturale  
Scocca singola in poliuretano da taglio bianco da rivestire o rivestita in tessuto

## Optional

Scocca con o senza braccioli mod. SALLY  
Scocca mod. FLORIDA  
Solo telaio con gambe in legno

## Misure

H. 460 mm telaio  
P. 450 mm telaio  
L. 470 mm telaio

*Frame SALLY WOOD with conic and semi-oval beech-wooden legs  
With foam shell, upholstered with fabric*

## Finishing

*Frame with painted central plate  
Beech-wooden legs or painted in nut colour  
Shell in white cut polyurethane to be upholstered or upholstered with fabric*

## Optional

*Shell with or without armrests mod. SALLY  
Shell mod. FLORIDA  
Only frame with wooden legs*

## Chair Measures

*H. 460 mm frame  
P. 450 mm frame  
L. 470 mm frame*



Con scocca Sally con braccioli  
With shell Sally with armrests



Adatto alle scocche / Suitable for the shells:



Con scocca Sally senza braccioli  
With shell Sally without armrests



Con scocca Florida con braccioli  
With shell Florida with armrests



Con scocca Florida senza braccioli  
With shell Florida without armrests

# Cesena

Telaio in tubo Asform d.25x2

## Finiture

Cromato

## Optional

Kit sedile e schienale con cornice in legno di faggio europeo naturale , verniciato (tinta ciliegio, noce, wenghè, miele, mogano o aniline di vari colori), o laccato bianco e nero con vera paglia di Vienna

Sedile e schienale in rete per esterno nera/beige/bianca o marrone

## Misure

H. 730 mm

P. 515 mm

L. 466 mm

Frame in Asform tube d.25x2

## Finishing

Chromed

## Optional

Kit seat and backrest with beechwood frame , natural, painted (cherry colour, nut colour, wenghè, honey colour, mahogany or anilines of different colours) or lacquered (black and white) with real strawpaper Vienna

Seat and backrest with outdoor mesh in black/beige/white or brown

## Measures

H. 730 mm

P. 515 mm

L. 466 mm



Il prodotto è una ri-edizione dell'originale CESCA di Knoll / S32 e S64 di Thonet e non può essere sostituito ad esse.

The product is a re-edition of the original article CESCA by Knoll / S32 and S64 by Thonet and it cannot replace them.

# Cesena Braccioli

Telaio in tubo Asform d.25x2  
con braccioli

## Finiture

Cromato

## Optional

Kit sedile e schienale con cornice in legno di faggio europeo naturale , verniciato (tinta ciliegio, noce, wenghè, miele, mogano o aniline di vari colori), o laccato bianco e nero con vera paglia di Vienna

Sedile e schienale in rete per esterno nera/beige/bianca o marrone

## Misure

H. 652 mm

P. 515 mm

L. 475 mm

*Frame in Asform tube d.25x2  
with armrests*

## Finishing

*Chromed*

## Optional

*Kit seat and backrest with beechwood frame , natural, painted (cherry colour, nut colour, wenghè, honey colour, mahogany or anilines of different colours) or lacquered (black and white) with real strawpaper Vienna*

*Seat and backrest with outdoor mesh in black/beige/white or brown*

## Measures

*H. 652 mm*

*P. 515 mm*

*L. 475 mm*



Il prodotto è una ri-edizione dell'originale CESCA di Knoll / S32 e S64 di Thonet e non può essere sostituito ad esse

*The product is a re-edition of the original article CESCA by Knoll / S32 and S64 by Thonet and it cannot replace them*



# Alma

Telaio in tubo da Ø 20 mm  
spess. 1,5 mm  
2 Altezze schienale disponibili  
Versione impilabile o non impilabile

## **Finiture**

Verniciato nero gofrato

## **Optional**

Rigenerato di cuoio  
Cuoio  
Ecopelle  
Braccioli

## **Misure**

H seduta 450 mm  
H schienale 860/930 mm  
P 490 mm  
L 440 mm

*Frame tube Ø 20 mm  
thickness 1.5 mm  
2 heights of the back available  
Version stackable frame or not stackable*

## **Finishing**

*Black painted*

## **Optional**

*Recycled leather  
Leather  
Friendly leather  
Armrests*

## **Measures**

*H seat 450 mm  
H back 860/930 mm  
P 490 mm  
L 440 mm*



# Red Bonded

Telaio in tubo rettangolare 25 x 10 mm  
2 altezze schienale disponibili

## Finiture

Verniciato nero

## Optional

Rigenerato di cuoio

Cuoio

## Misure

H seduta 470 mm

H schienale 830/930 mm

P 430 mm

L 430 mm

*Frame in rectangular tube 25 x 10 mm  
2 heights backrest available*

## Finishing

*Black painted*

## Optional

*Recycled Leather*

*Leather*

## Measures

*H seat 470 mm*

*H back 830/930 mm*

*P 430 mm*

*L 430 mm*





# Fargo

Telaio tubo da Ø 25mm conico  
Tubo ovale Ø 30x15mm  
spess. 1,5mm  
2 altezze schienali disponibili

## **Finiture**

Verniciato nero

## **Optional**

Rigenerato di cuoio  
Cuoio  
Ecopelle

## **Misure**

H seduta 470 mm  
H schienale 885/985 mm  
P 480 mm  
L 435 mm

*Frame tube Ø25mm conic  
Oval shaped tube Ø 30x15mm  
thickness 1,5mm  
2 heights of the backrest available*

## **Finishing**

*Black painted*

## **Optional**

*Recycled Leather  
Leather  
Friendly leather*

## **Measures**

*H seat 470 mm  
H back 885/985 mm  
P 480 mm  
L 435 mm*



Rigenerato / Cuoio  
Recycled Leather / Leather



Ecopelle  
Friendly leather

# Astral

Telaio in tubo 15 x 15 mm  
spess. 2,0 mm

**Finiture**  
Cromato  
Verniciato

**Optional**  
Scocca in legno Astral New sp. 10 mm  
Faggio verniciato naturale o tinto  
wenghé

**Misure**  
H 820 mm  
P 470 mm  
L 400 mm

*Frame tube 15 x 15 mm  
thickness 2,0 mm*

**Finishing**  
*Chromed  
Painted*

**Optional**  
*Wooden seat mod. Astral New th. 10 mm  
Natural beechwood or painted in wenghé  
colour*

**Measures**  
*H 820 mm  
P 470 mm  
L 400 mm*



# Quebec

Telaio in tubo 15 x 15 mm  
spess. 2 mm  
Impilabile

## Finiture

Cromato  
Verniciato

## Optional

Sedile in legno modello Quebec in  
faggio tinto naturale o wenghè o  
laccato bianco o nero

## Misure

H seduta 460 mm  
H schienale 840 mm  
P 500 mm  
L 490 mm

*Frame tube 15 x 15 mm  
thickness 2 mm  
Stackable*

## Finishing

*Chromed  
Painted*

## Optional

*Wooden seat mod. Quebec in natural  
beech or wenghè painted  
or lacquered in white or black*

## Measures

*H seat 460 mm  
H back 840 mm  
P 500 mm  
L 490 mm*





# Venezia

Telaio in tubo Ø 16 mm  
spessore 2,0 mm  
Impilabile

## Finiture

Cromato  
Verniciato

## Optional

Sedile in legno mod. Venezia in faggio  
tinto naturale, wenghè o laccato bianco  
o nero

## Misure

H 830 mm  
P 510 mm  
L 510 mm

*Frame tube Ø 16 mm  
thickness 2,0 mm  
Stackable*

## Finishing

*Chromed  
Painted*

## Optional

*Wooden seat mod. Venezia in natural  
beech or wenghè painted or lacquered  
in white or black*

## Measures

*H 830 mm  
P 510 mm  
L 510 mm*



# Malaga

Telaio in tubo da Ø 25 mm  
spess. 1,5 mm

**Finiture**  
Cromato  
Verniciato

**Optional**  
Seduta legno tamburato  
Seduta legno multistrato

**Misure**  
H seduta 435 mm  
H schienale 870 mm  
P 380 mm  
L 320 mm

*Frame tube Ø 25 mm  
thickness 1,5 mm*

**Finishing**  
*Chromed  
Painted*

**Optional**  
*Hollow core wooden seat  
Plywood wooden seat*

**Measures**  
*H seat 435 mm  
H back 870 mm  
P 380 mm  
L 320 mm*



# Marano 4 gambe / Slitta

Telaio slitta in tondino d.11 mm  
Telaio sedia 4 gambe in tubo d.18x2  
Impilabile  
Montaggio con scocca a incastro,  
senza viti

## Finiture

Cromato / Verniciato

## Optional

Scocca in plastica liscia o con fessure  
Ignifuga su richiesta  
Colori disponibili: bianco, nero, arancio  
ral 2004, blu ral 5002, carta da zucchero  
ral 5009, giallo ral 1028, grigio ral 7015,  
marrone ral 8023, rosso ral 3020, verde  
ral 6029

## Misure sedia 4 gambe

H 450 mm  
L 470 mm  
P 560 mm

## Misure slitta

H 450 mm  
L 520 mm  
P 490 mm

*Frame cantilever in wire d.11 mm  
Frame chair 4 legs in tube d.18x2  
Stackable  
Packing with clips,  
no screws*

## Finishing

*Chromed / Painted*

## Optional

*Plastic smooth shell or with holes  
Fireproof on demand  
Available colours: white, black, orange  
ral 2004, blue ral 5002, sugar paper ral  
5009, yellow ral 1028, grey ral 7015,  
brown ral 8023, red ral 3020, green ral  
6029*

## Measures 4 legs chair

*H 450 mm  
L 470 mm  
P 560 mm*

## Measures cantilever chair

*H 450 mm  
L 520 mm  
P 490 mm*



# Confort

Telaio in tubo da  $\varnothing$  25 – spess. 1,5mm  
Con e senza braccioli – Impilabile

## Finiture

Cromato  
Verniciato

## Optional

Kit plastiche con braccioli e senza braccioli per rivestimento  
Sedia fornita completa rivestita in tessuto

## Misure

H seduta 450 mm  
H schienale 750 mm  
P 500 mm  
L 450 mm



*Frame tube  $\varnothing$  25 – thickness 1,5mm  
With or without armrests – Stackable*

## Finishing

*Chromed  
Painted*

## Optional

*Kit plastics with or without armrests  
to be upholstered  
Completed upholstered chair*

## Chair Measures

*H seat 450 mm  
H back 750 mm  
P 500 mm  
L 450 mm*



# Iso

Telaio in tubo ovale 30x15 mm con o senza braccioli

## Finiture

Verniciato  
Cromato

## Optional

Kit sedile e schienale in plastica, legno o per rivestimento  
Portatavoletta  
Sedia completa rivestita in tessuto

## Misure

H 450 mm  
P 470 mm  
L 425 mm



*Frame in oval tube 30x15 mm with or without armrests*

## Finishing

*Painted  
Chromed*

## Optional

*Kit of seat and backrest in plastic, wood or to be upholstered  
Rack for board  
Upholstered completed chair*

## Measures

*H 450 mm  
P 470 mm  
L 425 mm*





# Top

Pieghevole con schienale  
in tubo Ø 25 mm e  
gambe in tubo Ø 22 mm

## Finiture

Verniciato  
Cromato

## Optional

Seduta imbottita  
Telaio Portatavoletta

## Misure

Aperta	Chiusa
H 860 mm	H 980 mm
P 600 mm	P 100 mm
L 500 mm	L 500 mm

*Folding chair with backrest  
in tube Ø 25 mm  
and legs in tube Ø 22 mm*

## Finishing

*Painted  
Chromed*

## Optional

*Upholstered seat  
Rack for board*

## Chair Measures

<i>Opened</i>	<i>Closed</i>
<i>H 860 mm</i>	<i>H 980 mm</i>
<i>P 600 mm</i>	<i>P 100 mm</i>
<i>L 500 mm</i>	<i>L 500 mm</i>



# School

Telaio in tubo da Ø 22 mm spes. 1,5 mm  
Impilabile

## Finiture

Cromato  
Verniciato

## Optional

Kit plastiche sedile + schienale in Blu Ral 5017 o Rosso Ral 3002

Altri colori per quantità superiori ai 500 pezzi

## Misure

H seduta 450 mm  
H schienale 780 mm  
P 510 mm  
L 370 mm

*Frame tube Ø 22 mm thickness 1,5 mm  
Stackable*

## Finishing

*Chromed  
Painted*

## Optional

*Kit plastic seat + backrest in Blue Ral 5017 or Red Ral 3002*

*Other colours for quantities over 500 pieces*

## Chair Measures

*H seat 450 mm  
H back 780 mm  
P 510 mm  
L 370 mm*



SGABELLI  
*STOOLS*

# SEDUTE SEATS



Felix



Pillo Wood



Pillo Ecopelle

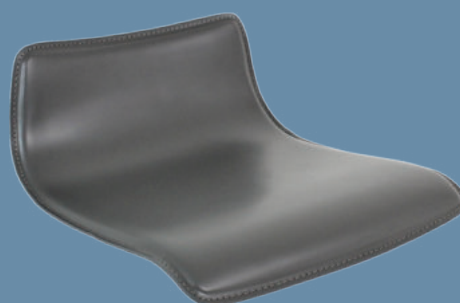

Diva



Rainbow



Macis



Lilla



Rimini



Pisa



Pisa Ecopelle



Pisa Wood



Pisa Sughero



Spice



Ken

# Nicolino S



Telaio in tondino d.22 con cuscino al 100% in lana riciclata  
Due altezze disponibili

*Frame in wire d.22 with cushion made by 100% recycled wool  
Two heights available*

## Finiture

Telaio verniciato nero ral 9005 o bianco ral 9003 gofrato opaco  
Cuscino in 3d in tessuto DAMA 100% lana riciclata

## Finishing

*Black painted frame in ral 9005 rough and matt  
White painted frame in ral 9003 rough and matt  
3D cushion in DAMA fabric, 100% recycled wool*

## Colori disponibili

Blu 0048 - Rosso 058 - Grigio chiaro 0057 - Verde 0064 - Grigio scuro 0002

## Available colours

*Blue 0048 - Red 058 - Light grey 0057 - Green 0064 - Dark grey 0002*



## Misure

H. 964 mm o 895 mm  
P.535 mm della versione alta, 524 mm della versione bassa  
L. 577 mm

## Measures

*H. 964 mm or 895 mm  
P.535 mm for the high version, 524 mm for the low version  
L. 577 mm*



# Cesena S

Telaio in tubo Asform d.25x2  
Con poggiapiedi in tubo d.22x2 mm

## Finiture

Cromato  
Verniciato bianco ral 9010 opaco liscio  
Verniciato nero ral 9005 opaco liscio

## Optional

Kit sedile e schienale con cornice  
in legno di faggio europeo naturale,  
verniciato (tinta ciliegio, noce, wenghè,  
miele, mogano o aniline di vari colori),  
laccato bianco e nero con vera paglia di  
Vienna o con rete plastificata (batilina)  
colore nero-bianco-beige-marrone

## Misure

H. 915 mm / 1015 mm  
P. 475 mm  
L. 440 mm

*Frame in Asform tube d.25x2  
With footrest in tube d.22x2 mm*

## Finishing

*Chromed  
White painted ral 9010 matt and smooth  
Black painted ral 9005 matt and smooth*

## Optional

*Kit seat and backrest with beechwood  
frame, natural, painted (cherry colour,  
nut colour, wenghè, honey colour,  
mahogany or anilines of different colours)  
or lacquered (black and white) with real  
strawpaper Vienna or with plasticized net  
(batiline), colours: black-white-beige-  
brown*

## Measures

*H. 915 mm / 1015 mm  
P. 475 mm  
L. 440 mm*



Il prodotto è una ri-edizione dell'originale CESCO di Knoll / S32 e S64 di Thonet e non può essere sostituito ad esse

*The product is a re-edition of the original article CESCO by Knoll / S32 and S64 by Thonet and it cannot replace them*







# Felix

Telaio in tubo d.22  
Poggiapiedi con battitacco montato

## Finiture

Verniciato grigio gofrato ral 7021  
Seduta in legno truciolare rivestito in tessuto

## Misure

H 680 mm solo telaio / 730 mm con  
sedile montato  
P 410 mm  
L 410 mm

*Frame in tube d.22 with footrest and  
plastic cover assembled*

## Finishing

*Painted grey ral 7021 embossed  
Wooden seat upholstered with fabric*

## Measures

*H 680 mm only frame / 730 mm with  
seat  
P 410 mm  
L 410 mm*





# Pisa Regolabile

Telaio in tondino da Ø 12 mm

Con vitone regolabile, corsa 130 mm

Frame wire Ø 12 mm

With adjustable mechanism, extension 130 mm

## Finiture

Cromato  
Verniciato

## Finishing

Chromed  
Painted

## Optional

Solo vitone regolabile  
Seduta in legno mod. Pisa Wood  
Seduta rivestita  
Seduta in sughero

## Optional

Only adjustable mechanism  
Wooden seat mod. Pisa Wood  
Upholstered seat  
Cork seat

## Misure

H 630 mm del telaio  
H 740 mm del telaio  
P 370 mm  
L 460 mm

## Measures

H 630 mm (only frame)  
H 740 mm (only frame)  
P 370 mm  
L 460 mm



Con sedile in ecopelle  
With upholstered seat in friendly leather



Con sedile in sughero / With cork seat



# Pisa

Telaio in tondino da Ø 12 mm

## Finiture

Cromato  
Verniciato

## Optional

Seduta in metallo  
Seduta in legno mod. Pisa Wood  
Seduta rivestita  
Seduta in sughero

## Misure

H 740 mm  
P 370 mm  
L 460 mm

Frame wire Ø 12 mm

## Finishing

Chromed  
Painted

## Optional

Metal seat  
Wooden seat mod. Pisa Wood  
Upholstered seat  
Cork seat

## Measures

H 740 mm  
P 370 mm  
L 460 mm

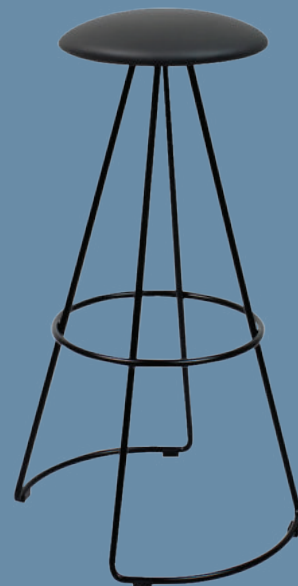

Con sedile in ecopelle  
With upholstered seat in friendly leather



Con sedile in metallo  
With metal seat



Con sedile in sughero  
With cork seat



# Rio

Telaio in tubo Ø 50 mm  
Alzata a gas Ø 40 mm  
Base Ø 390 mm o 390 x 390 mm  
Poggiapiedi in lama

## Finiture

Cromato

## Optional

Seduta in legno  
Seduta rivestita  
Seduta in poliuretano  
Seduta in sughero  
Kit blocchetto estetico con piastra  
quadra e leva dritta  
Base per fissaggio a terra

## Misure

H senza sedile 520/780 mm  
P 400 mm  
L 400 mm

*Frame tube Ø 50 mm  
Gaslift Ø 40 mm  
Base Ø 390 mm or 390 x 390 mm  
Footrest in steel*

## Finishing

*Chromed*

## Optional

*Wooden seat  
Upholstered seat  
Polyurethane seat  
Cork seat  
Aesthetical join for tube with plate and  
straight lever  
Base to be fixed to the ground*

## Measures

*H without seat 520/780 mm  
P 400 mm  
L 400 mm*



Adatto alle sedute / Suitable for:



Pillo Ecopelle



Diva



Rainbow



Macis



Pillo Wood



Rimini



Spice



Lilla



Ken

# Milton

Telaio in tubo da 50x50 mm  
Alzata a gas da Ø 40 mm  
Base Ø 390 mm o 390x390 mm  
Poggiapiedi in lama trafilato

## Finiture

Cromato

## Optional

Seduta in legno  
Seduta rivestita  
Seduta in poliuretano  
Seduta in sughero  
Kit blocchetto estetico con piastra  
quadra e leva dritta  
Base per fissaggio a terra

## Misure

H senza sedile 520/780 mm  
P 400 mm  
L 400 mm

*Frame tube 50X50 mm  
Gaslift Ø 40 mm  
Base Ø 390 mm or 390 x 390 mm  
Footrest in steel*

## Finishing

*Chromed*

## Optional

*Wooden seat  
Upholstered seat  
Polyurethane seat  
Cork seat  
Aesthetical join for tube with plate and  
straight lever  
Base to be fixed to the ground*

## Measures

*H without seat 520/780 mm  
P 400 mm  
L 400 mm*



Con sedile Rainbow  
With seat mod. Rainbow



Con sedile Rimini  
With seat mod. Rimini

Adatto alle sedute / Suitable for:



Pillo Ecopelle



Pillo Wood



Ken



Diva



Spice



Macis



Lilla

# Perugia

Telaio in tubo da Ø 60/50 mm  
Base Ø 390 mm o 390 x 390 mm  
o campana Ø 440 mm

## Finiture

Cromato

## Optional

Seduta in legno  
Seduta rivestita  
Seduta in poliuretano  
Seduta in sughero  
Kit blocchetto estetico con piastra  
quadra e leva dritta  
Base per fissaggio a terra  
Base Campana

## Misure

H senza sedile 520/780 mm  
P 400 mm  
L 400 mm

*Frame tube Ø 60/50 mm  
Base Ø 390 mm or 390 x 390 mm  
or trumpet base Ø 440 mm*

## Finishing

*Chromed*

## Optional

*Wooden seat  
Upholstered seat  
Polyurethane seat  
Cork seat  
Aesthetical join for tube with plate and  
straight lever  
Base to be fixed to the ground  
Trumpet base*

## Measures

*H without seat 520/780 mm  
P 400 mm  
L 400 mm*



Con sedile mod. LILLA  
With seat mod. LILLA



Con sedile Pillo ecopelle  
With seat mod. Pillo friendly leather

Adatto alle sedute / Suitable for:



Rainbow



Pillo Wood



Ken



Diva



Spice



Macis



Rimini

# Pillo

Telaio in tubo da Ø 60/50 mm  
Base Ø 390 mm o 390 x 390 mm  
o campana Ø 440 mm

## Finiture

Cromato

## Optional

Seduta in legno  
Seduta rivestita  
Seduta in poliuretano  
Seduta in sughero  
Kit blocchetto estetico con piastra  
quadra e leva dritta  
Base per fissaggio a terra  
Base Campana

## Misure

H senza sedile 520/780mm  
P 400 mm  
L 400 mm

*Frame tube Ø 60/50mm  
Base Ø 390mm or 390 x 390mm  
or trumpet base Ø 440*

## Finishing

*Chromed*

## Optional

*Wooden seat  
Upholstered seat  
Polyurethane seat  
Cork seat  
Aesthetical join for tube with plate and  
straight lever  
Base to be fixed to the ground  
Trumpet base*

## Measures

*H without seat 520/780 mm  
P 400 mm  
L 400 mm*



Con sedile Pillo legno / With seat mod. Pillo wood



Con sedile Lilla / With seat mod. Lilla

Adatto alle sedute / Suitable for:



Rainbow



Pillo Ecopelle



Ken



Diva



Spice



Macis



Rimini



# Panama

Telaio in tubo da Ø 60/50 mm  
Poggia piedi trafilato da Ø 11 mm  
Base Ø 390 mm o 390 x 390 mm  
o Ø 440 mm campana

## Finiture

Cromato

## Optional

Seduta in legno  
Seduta rivestita  
Seduta in poliuretano  
Seduta in sughero  
Kit blocchetto estetico con piastra  
quadra e leva dritta  
Base per fissaggio a terra  
Base Campana

## Misure

H senza sedile 520/780 mm  
P 400 mm  
L 400 mm

*Frame tube Ø 60/50mm  
Footrest drawn Ø 11mm  
Base Ø 390mm or 390 x 390 mm  
or trumpet base Ø 440 mm*

## Finishing

*Chromed*

## Optional

*Wooden seat  
Upholstered seat  
Polyurethane seat  
Cork seat  
Aesthetical join for tube with plate and  
straight lever  
Base to be fixed to the ground  
Trumpet base*

## Measures

*H without seat 520/780 mm  
P 400 mm  
L 400 mm*

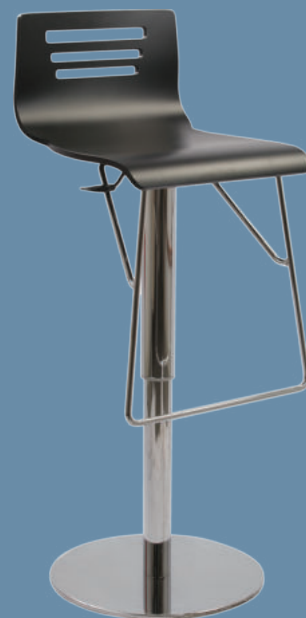

Con sedile Rimini / With seat mod. Rimini



Con sedile Lilla / With seat mod. Lilla

Adatto alle sedute / Suitable for:



Pillo Ecopelle



Pillo Wood



Ken



Diva



Spice



Macis



Rainbow

# Toronto

Telaio in tubo d.60, alzata a gas d. 50 mm  
Base Ø 390 mm o 390 x 390 mm  
o campana Ø 440 mm

## Finiture

Cromato

## Optional

Seduta in legno  
Seduta rivestita  
Seduta in poliuretano  
Seduta in sughero  
Kit blocchetto estetico con piastra  
quadra e leva dritta  
Base per fissaggio a terra  
Base Campana

## Misure

H senza sedile 520/780 mm  
P 400 mm  
L 400 mm

*Tube d.60 mm, Gaslift d.50 mm  
Base Ø 390 mm or 390 x 390 mm or  
trumpet base Ø 440 mm*

## Finishing

*Chromed*

## Optional

*Wooden seat  
Upholstered seat  
Polyurethane seat  
Cork seat  
Aesthetical join for tube with plate and  
straight lever  
Base to be fixed to the ground  
Trumpet base*

## Measures

*H without seat 520/780 mm  
P 400 mm  
L 400 mm*



Con sedile Rainbow / With seat mod. Rainbow



Con sedile Diva / With seat mod. Diva

Adatto alle sedute / Suitable for:



Pillo Ecopelle



Pillo Wood



Ken



Lilla



Spice



Macis



Rimini

# Slot76

Base Ø 440 – Ø 480 mm a campana  
Colonna Ø 76 mm  
Versione girevole o autoallineante o  
alzata a gas con autoallineante  
2 altezze disponibili

## Finiture

Cromato

## Optional

Seduta in legno  
Seduta in legno rivestita  
Seduta in poliuretano  
Auto allineante  
Alzata a gas con autoallineante

## Misure

H senza seduta 564 – 633 mm  
P 440 mm  
L 440 mm

*Trumpet base Ø 440 – Ø 480 mm,  
Column Ø 76 mm  
Versions: swivel or with self-turning  
mechanism or gaslift + self-turning  
mechanism  
2 heights available*

## Finishing

*Chromed*

## Optional

*Wooden seat  
Upholstered wooden seat  
Polyurethane seat  
Gaslift with self-turning mechanism  
Self-turning mechanism*

## Measures

*H without seat 564 – 633 mm  
P 440 mm  
L 440 mm*



Con sedile Lilla / With seat mod. Lilla



Con sedile Macis / With seat mod. Macis

Adatto alle sedute / Suitable for:



Pillo Ecopelle



Pillo Wood



Ken



Diva



Spice



Rainbow



Rimini

# Detroit

Telaio in tondino Ø 11 mm – Impilabile  
Due altezze disponibili

## **Finiture**

Cromato  
Verniciato

## **Optional**

Seduta in legno  
Seduta in poliuretano

## **Misure**

H 650/740 mm  
P 470 mm  
L 540 mm

Frame wire Ø 11 mm – Stackable  
Two heights available

## **Finishing**

Chromed  
Painted

## **Optional**

Wooden seat  
Polyurethane seat

## **Measures**

H 650/740 mm  
P 470 mm  
L 540 mm



Con sedile Rimini / With seat mod. Rimini



Adatto alle sedute / Suitable for:



Rainbow

# Venezia

Telaio in tubo Ø 16 mm  
spessore 2,0 mm  
Impilabile

**Finiture**  
Cromato  
Verniciato

**Optional**  
Seduta in legno  
Seduta rivestita  
Seduta in poliuretano

**Misure**  
H 640 / 740 mm  
P 510 mm  
L 480 mm

*Frame tube Ø 16 mm  
thickness 2,0 mm  
Stackable*

**Finishing**  
*Chromed  
Painted*

**Optional**  
*Wooden seat  
Upholstered seat  
Polyurethane seat*

**Measures**  
*H 640 / 740 mm  
P 510 mm  
L 480 mm*



Con sedile Rimini / With seat mod. Rimini



Adatto alle sedute / Suitable for:



Pillo Ecopelle



Pillo Wood



Rainbow

# Malaga S

Telaio in tubo Ø 25 mm x 1,5 mm  
2 altezze

## **Finiture**

Cromato  
Verniciato

## **Optional**

Seduta legno tamburato  
Seduta legno multistrato

## **Misure**

H seduta 670 / 740 mm  
H schienale 920 mm  
P 380 mm  
L 320 mm

*Frame tube Ø 25 mm x 1,5 mm  
2 heights*

## **Finishing**

*Chromed  
Painted*

## **Optional**

*Hollow core wooden seat  
Plywood wooden seat*

## **Measures**

*H seat 670 / 740 mm  
H back 920 mm  
P 380 mm  
L 320 mm*



# Alma S

Telaio in tubo d.20 sp. 1,5 mm  
2 altezze disponibili

## Finiture

Verniciato nero con poggiatesta cromato

## Optional

Rigenerato di cuoio  
Cuoio

## Misure

H seduta 650/770 mm  
H schienale 870/990 mm  
P 580 mm  
L 480 mm

Frame tube Ø 20 mm – thickness 1.5 mm  
2 heights available

## Finishing

*Black painted frame with chromed foorest*

## Optional

*Recycled Leather  
Leather*

## Measures

*H seat 650/770 mm  
H backrest 870/990 mm  
P 580 mm  
L 480 mm*







# Tropea Wood S

Telaio in trafilato d.11 mm pieno  
Con gambe in legno

## **Finiture**

Telaio cromato o verniciato  
Gambe in legno faggio naturale, tinto  
noce o frassino

## **Optional**

Seduta in legno  
Seduta rivestita

## **Misure**

H 650 mm  
P 500 mm  
L 500 mm

*Frame in wire d.11 mm  
With wooden legs*

## **Finishing**

*Chromed frame  
Painted frame  
Wooden legs in natural beech, nut  
colour or ash*

## **Optional**

*Wooden seat  
Upholstered seat*

## **Measures**

*H 650 mm  
P 500 mm  
L 500 mm*



Con sedile Diva / With seat mod. Diva



POLTRONE /  
ATTESA  
*ARMCHAIRS /*  
*WAITING ROOM*  
*CHAIRS*

Telaio in tubo d.30x2 mm  
 Scocca in feltro con materiale al 100%  
**RICICLATO** (70% di bottiglie di plastica  
 riciclata, 30% residui di cotone) con  
 cuscino in 3d rivestito in tessuto  
 Woolland

## Finiture

Telaio verniciato nero ral 9005 opaco  
 liscio  
 Telaio verniciato bianco ral 9003 opaco  
 liscio  
 Altre verniciature su richiesta  
 Scocca in feltro grigio scuro o grigio  
 chiaro  
 Cuscino a scelta tra vari colori

## Misure

H. 651 mm  
 P. 764 mm  
 L. 781 mm

*Frame in tube d.30x2 mm  
 Shell made of felt 100%  
 RECYCLED (70% of recycled PET  
 bottles, 30% cotton residue) with 3D  
 cushions upholstered with Woolland  
 fabric*

## Finishing

*Black painted frame ral 9005 matt and  
 smooth  
 White painted frame ral 9003 matt and  
 smooth  
 Other colours on demand  
 Felt shell in dark grey or light grey colour  
 Cushion in different colours*

## Measures

*H. 651 mm  
 P. 764 mm  
 L. 781 mm*



# Aloe D

Aloe divano con spalla alta e schienale  
*Aloe sofa with high leg and backrest*

Aloe divano con spalla alta  
*Aloe sofa with high leg*

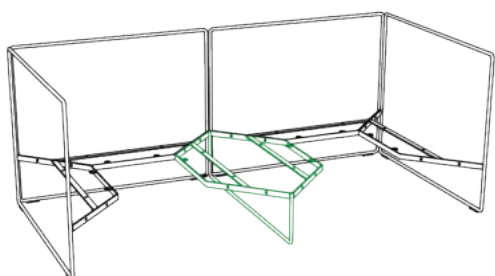

Due posti  
*Two seats*

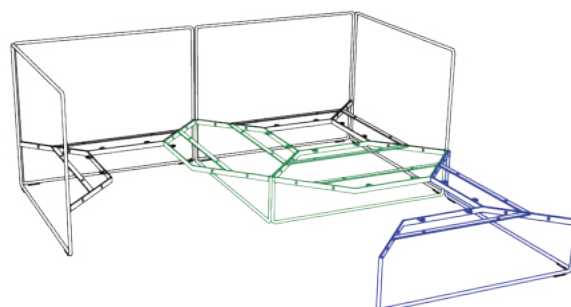

Due posti con penisola  
*Two seats + additional low seat*

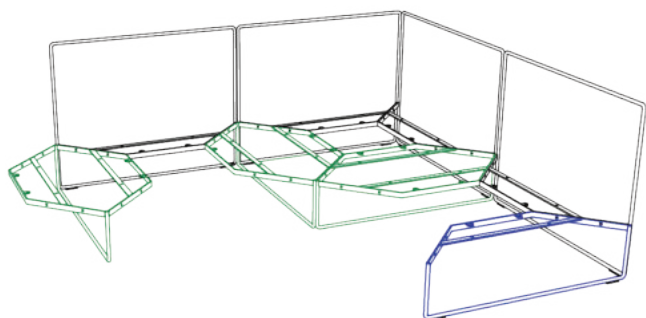

Quattro posti con sbalzo  
*Four seats + magazine rack*

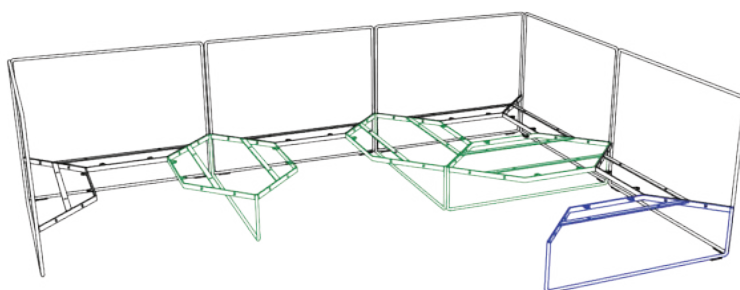

Cinque posti  
*Five seats*

# Aloe D

## **Aloe spalla alta**

Telaio in tondino d.12 mm con lame 20x5  
Universale per fianchi e retro schienali  
Ferro cromato

## **Aloe spalla bassa**

Telaio in tondino d.12 mm con lame 20x5  
Per parti terminali senza braccioli o per pouff  
Ferro cromato

## **Aloe spalla bassa doppia**

Telaio in tondino d.12 mm con lame 20x5  
Per parte centrale multi-seduta di rinforzo seduta in legno o per terminale senza bracciolo e supporto porta riviste  
Ferro cromato

## **Aloe schienale alto inclinato da rivestire**

Telaio in tubo d.20x2 con lama con 2 piastrine a C per fissaggio al legno della seduta (spessore seduta massimo 25 mm)  
Ferro verniciato nero opaco liscio  
Senza tela/rete

## **High leg Aloe**

*High leg in wire d.12 mm with blades 20x5  
Universal for right and left side and seatback  
Chromed*

## **Low single leg Aloe**

*Low single leg in wire d.12 mm with blades 20x5  
For terminal part without armrest or as pouff  
Chromed*

## **Low double leg Aloe**

*Low double leg in wire d.12 mm with blades 20x5  
For central part as junction between the seats or for terminal part without armrests or as support for magazine rack  
Chromed*

## **High sloped backrest Aloe to be upholstered**

*Frame in tube d.20x2 with blade with 2 plates to fix on the wooden seat (thickness maximum 25 mm)  
Painted black matt smooth  
Without mesh, to be upholstered*



Spalla alta / High leg



Spalla bassa / Low single leg



Spalla bassa doppia / Low double leg

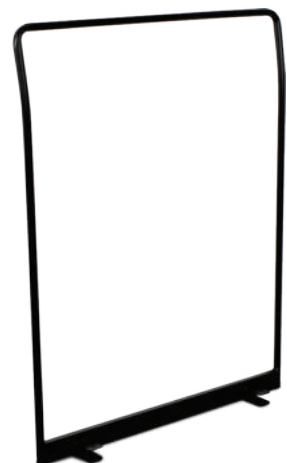

Schienale / Backrest

# Arizona

Scocca in poliuretano da rivestire  
Base a scelta tra i nostri modelli standard

## Finiture

Scocca rivestita in ecopelle  
Scocca rivestita in pelle  
Struttura cromata o verniciata

## Misure

Scocca  
H 390 mm  
P 390 mm  
L 580 mm

*Polyurethane shell to be upholstered  
Base at customer's choice between our standard models*

## Finishing

*Eco-leather shell  
Leather shell  
Chromed or painted structure*

## Measures

*Shell  
H 390 mm  
P 390 mm  
L 580 mm*



Con base Lido / With Lido base



Con base BURANO  
With BURANO base

Adatto alle basi / Suitable for bases



Base Elba



Base Cork

# Georgia

Telaio slitta in tondino d.12 mm  
Scocca in poliuretano rivestita in tessuto

## Finiture

Telaio verniciato o cromato  
Tessuto su richiesta

## Optional

Scocca in poliuretano da rivestire  
Altri basamenti su richiesta (con colonne girevoli, fisse, con auto-allineante o alzate a gas) tra i nostri modelli standard

## Misure

H. 890 mm  
P. 760 mm  
L. 900 mm

*Wire sled frame d.12 mm  
Upholstered polyurethane shell with fabric*

## Finishing

*Painted or chromed frame  
Fabric on demand*

## Optional

*Polyurethane shell to be upholstered  
Other bases on demand (with swivel or fixed columns, with self-turning mechanism or gaslifts) between our standard models*

## Measures

*H. 890 mm  
P. 760 mm  
L. 900 mm*



Con base Cork / With Cork base



Adatto alle basi / Suitable for bases



Lido

# Morgan

Telaio in acciaio Asform 25x2  
Versione impilabile o non impilabile

## Finiture

Cromato  
Verniciato

## Optional

Kit plastiche, seduta, schienale, braccioli  
Schienale alto  
Schienale in rete

## Misure

H 660 mm  
P 565 mm  
L 545 mm

*Asform steel frame 25 x 2*  
*Stackable or not stackable*

## Finishing

*Chromed*  
*Painted*

## Optional

*Kit plastics, seat, back, armrests*  
*High backrest*  
*Mesh backrest*

## Measures

*H 660 mm*  
*P 565 mm*  
*L 545 mm*



Con schienale in rete / With mesh backrest

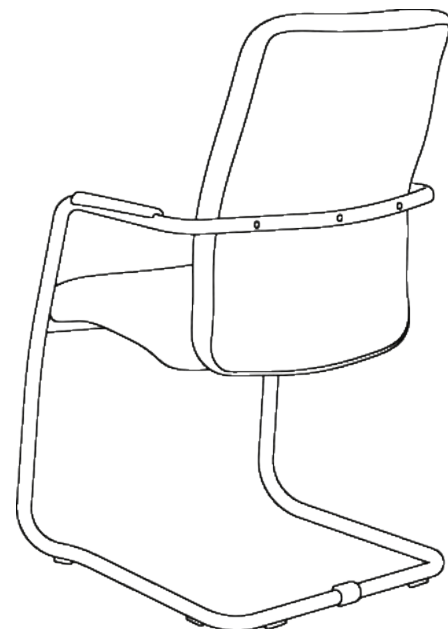

Con schienale ALTO / With HIGH backrest



# Morgan 4 Gambe

Telaio in tubo Ø 25 x 2 mm  
in ferro normale

## Finiture

Cromato  
Verniciato

## Optional

Kit plastiche, seduta, schienale, braccioli  
Schienale alto  
Schienale in rete

## Misure

H 660 mm  
P 656 mm  
L 545 mm

Frame tube Ø 25 x 2 mm  
normal iron

## Finishing

Chromed  
Painted

## Optional

Kit plastics, seat, backrest, armrests  
High backrest  
Mesh backrest

## Measures

H 660 mm  
P 656 mm  
L 545 mm



Con schienale in rete / With mesh backrest



# Morgan G

Telaio in tubo Ø 25 x 2 mm in ferro normale  
Con piastra saldata attacco conico applicabile a tutte le nostre colonne / alzate a gas

## Finiture

Cromato  
Verniciato

## Optional

Kit plastiche, seduta, schienale, braccioli  
Base: Elba - Cork - Lido - Murano - Burano - Venezia  
Per colonne girevoli / con autoallineante e alzate a gas  
Schienale in rete

## Misure

H variabile a seconda della base  
P 565 mm  
L 545 mm

*Frame tube Ø 25 x 2 mm normal iron  
With welded conic plate to be fixed to all our columns and gaslifts*

## Finishing

*Chromed  
Painted*

## Optional

*Kit plastics, seat, back, armrests  
Base: Elba - Cork - Lido - Murano - Burano - Venezia  
For swivel columns / with self-turning mechanism or gaslifts  
Mesh backrest*

## Measures

*H depending on the base  
P 565 mm  
L 545 mm*



Con base BURANO / With BURANO base



Con base VENEZIA / With VENEZIA base



Adatto alle basi / Suitable for the bases:



Elba



Cork



Lido



Murano

# Silla

Telaio in tubo da Ø 25mm  
spess. - 2,0mm  
Traverso anteriore smontabile

**Finiture**  
Cromato

**Optional**  
Rivestimento in Sky nero

**Misure**  
H 610 mm  
P 530 mm  
L 540 mm

*Frame tube Ø 25mm  
thickness 2,0mm  
Removable anterior tube*

**Finishing**  
*Chromed*

**Optional**  
*Upholstery with black Sky*

**Measures**  
*H 610 mm  
P 530 mm  
L 540 mm*



# Berna

Telaio in trafilato 35 x 12 mm  
Smontabile fianco sinistro, destro e  
centrale per divano.

## Finiture

Cromato

## Optional

Kit cinghie montate su telaio  
Kit cuscini in pelle o ecopelle  
Divano e pouff a 2/3 posti

## Misure Poltrona

H 740 mm  
P 750 mm  
L 670 mm

Il prodotto "Berna" non è conforme  
all'originale e non può essere  
sostituito all'originale.  
Per l'originale rivolgersi alla "KNOLL  
GERMANIA".

*Frame in drawn steel 35x12mm  
Detachable left side, right side and cen-  
tral side for couch.*

## Finishing

*Chromed*

## Optional

*Kit straps assembled on the frame  
Kit cushions in leather or friendly-leather  
Sofa and pouff with 2 / 3 seats*

## Armchair Measures

*H 740 mm  
P 750 mm  
L 670 mm*

*The product "Berna" does not cor-  
respond to the original design and it  
cannot substitute the original version.  
For the original version and design  
please contact the company KNOLL  
GERMANIA.*



# Toledo / Toledo D

Telaio in tubo d.25 mm sp. 1,5 mm  
Telaio poltrona, divano a 2 posti o  
divano a 3 posti  
Tutto smontabile  
Fornito in kit su scatola singola

## Finiture

Cromato

## Optional

Kit spugne da rivestire su richiesta

Kit cuscini in pelle o ecopelle su richiesta

## Misure

H. 680 mm

P. 700 mm

L. 760 mm per poltrona

1290 mm per divano a 2 posti

1790 mm per divano a 3 posti

Il prodotto "Toledo" non è conforme all'originale e non può essere sostituito all'originale. Per l'originale rivolgersi alla ditta CASSINA ITALIA.

*Frame in tube d.25 mm, th.1,5 mm  
Frame for armchair, 2 or 3 seater sofa  
All detachable  
Supplied in a kit in a single box*

## Finishing

*Chromed*

## Optional

*Kit of foams to be upholstered on demand*

*Kit of leather or friendly-leather cushions on demand*

## Measures

*H. 680 mm*

*P. 700 mm*

*L. 760 mm for armchair*

*1290 mm for two-seater sofa*

*1790 mm for three-seater sofa*

*The product "Toledo" does not correspond to the original design and it cannot substitute the original version. For the original version and design please contact the company CASSINA ITALIA*



Poltrona / Armchair



Divano a 2 posti / 2 seater sofa



Divano a 3 posti / 3 seater sofa



PANCHE  
*BENCHES*

# Cuba

Telaio in tondino d.11 con 2 o 4 lame a scelta

*Frame in wire d.11 mm with 2 or 4 blades on demand*

## Finiture

Cromato  
Verniciato nero / bianco

## Finishing

*Chromed  
Painted in black / white*

## Optional

Piano in legno multistrato  
Cuscino 350x350 rivestito in tessuto  
100% di Lana riciclata  
Colori disponibili : Blu 0048 - Rosso  
058 - Grigio chiaro 0057 - Verde 0064 -  
Grigio scuro 0002

## Optional

*Plywood wooden seat  
Cushion 350x350 upholstered in fabric  
100% of recycled wool  
Available colours: Blue 0048 – Red 058  
– Light grey 0057 – Green 0064 – Dark  
grey 0002*



## Misure

A seconda della composizione scelta

## Measures

*Depending on the composition required*

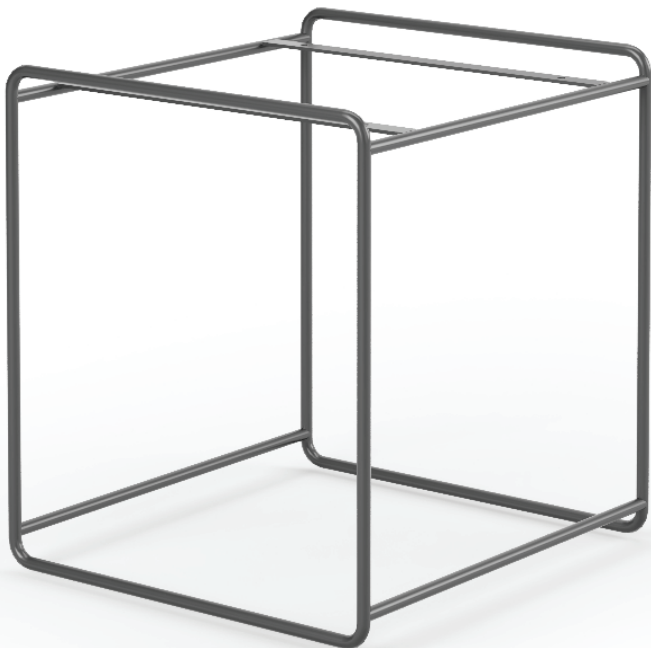





# Panca Universale

Gamba in tondino d.12 mm e trave in tubo 80x40 mm  
Cavalotto per seduta o piastra reggiseduta per sedute con interasse fori 150x150 mm

## Finiture

Cromata  
Verniciata (indoor o outdoor)

## Optional

Sedute su richiesta  
Trave da 2 a 5 posti

## Misure

H. 850 mm  
P. 620 mm  
L. da 1200 mm a 2700 mm a seconda dei posti

*Leg in wire d.12 mm and beam in tube 80x40 mm  
Support for beam or plates for seats with hole distance 150x150 mm*

## Finishing

*Chromed  
Painted (indoor or outdoor use)*

## Optional

*Seats on demand  
Beam from 2 to 5 seats*

## Measures

*H. 850 mm  
P. 620 mm  
L. from 1200 mm to 2700 mm depending on the number of the seats*



TAVOLI  
*TABLES*

# Piani / Tops

## **Finiture**

Legno nobilitato  
Legno laminato  
Legno laccato  
Vetro temperato trasparente  
Vetro temperato fumè  
Polipropilene  
Gres

## **Finishing**

*Chipboard wooden top*  
*Laminated wooden top*  
*Lacquered wooden top*  
*Transparent tempered glass top*  
*Smoked tempered glass top*  
*Polypropylene*  
*Stoneware*

## **Misure**

d. 600 / 600x600  
d. 700 / 700x700  
d. 800 / 800x800

## **Measures**

*d. 600 / 600x600*  
*d. 700 / 700x700*  
*d. 800 / 800x800*

Altre misure su richiesta

*Other measures on demand*

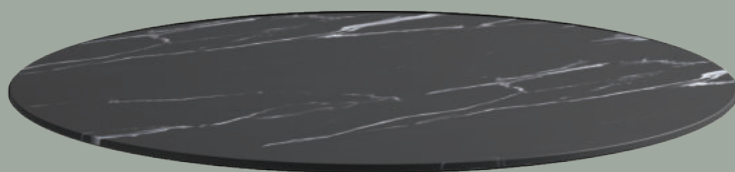



# Giglio

Struttura con base tonda d.500 sp.6 mm con feltrini  
In tondino d.11 mm  
Due altezze disponibili

## **Finiture**

Verniciato per interni  
Verniciato per esterni

## **Optional**

Piano su richiesta in legno / lamiera / vetro

## **Misure**

Base d. 500 mm  
H. 740 mm / 1080 mm

*Frame with round base d.500 th.6 mm with felts  
In wire d.11 mm  
Two heights available*

## **Finishing**

*Painted for indoor use  
Painted for outdoor use*

## **Optional**

*Top on demand in wood / metal sheet / glass*

## **Measures**

*Base d. 500 mm  
H. 740 mm / 1080 mm*





# Abundantia Tondo / Round

Prodotto registrato n. 009072754-0002  
Struttura in tondino d.11 e anelli in tubo  
d.16x2 mm  
Con piedini regolabili

*Registered product n. 009072754-0002  
Frame in wire d.11 and rings in tube  
d.16x2 mm  
With adjustable glides*

## **Finiture**

Verniciato nero ral 9005 / bianco ral  
9010 / bronzo  
Sali di zinco e vernice per esterni

## **Finishing**

*Black painted ral 9005 / white painted ral  
9010 / bronze painted  
Painted for outdoor use with double treat-  
ment*

## **Optional**

Piano in legno o vetro d.1000 /d.1400 mm  
Versione MAGNUM per piani da d.1400  
mm a 1800 mm

## **Optional**

*Wooden or glass top d.1000 / d.1400 mm  
Version MAGNUM for tops from d.1400  
mm to 1800 mm*

## **Misure**

H. 725 mm  
P. 600 mm  
L. 600 mm

## **Measures**

*H. 725 mm  
P. 600 mm  
L. 600 mm*

## **Versione MAGNUM:**

H. 725 mm  
P. 800 mm  
L. 800 mm

## **Version MAGNUM:**

*H. 725 mm  
P. 800 mm  
L. 800 mm*



Per piani da d.1000 mm a d. 1400 mm  
*For tops from d.1000 mm to d. 1400 mm*

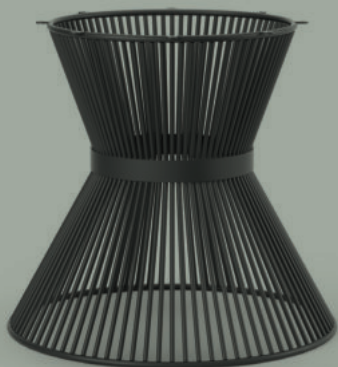

Versione MAGNUM, per piani da d. 1400 mm a d. 1800 mm  
*Version MAGNUM, for tops from d. 1400 mm a d. 1800 mm*







# Abundantia Ovale / Oval

Prodotto registrato n. 009072754-0001  
Struttura in tondino d.11 e anelli in tubo  
d.16x2 mm  
Con piedini regolabili

*Registered product n. 009072754-0001  
Frame in wire d.11 and rings in tube  
d.16x2 mm  
With adjustable glides*

## **Finiture**

Verniciato nero ral 9005 / bianco ral  
9010 / bronzo  
Sali di zinco e vernice per esterni

## **Finishing**

*Black painted ral 9005 / white painted  
ral 9010 / bronze painted  
Painted for outdoor use with double  
treatment*

## **Optional**

Piano in legno o vetro  
900x1400-2500 mm  
Versione allungabile  
Versione MAGNUM per piani  
da l. 2200 mm a l. 3000 mm

## **Optional**

*Wooden or glass top  
900x1400-2500 mm  
Extendable version  
Version MAGNUM for tops  
from l. 2200 mm to l. 3000 mm*

## **Misure**

H. 725 mm  
P. 550 mm  
L. 1040 mm

## **Measures**

*H. 725 mm  
P. 550 mm  
L. 1040 mm*

Versione MAGNUM

H. 725 mm  
P. 550 mm  
L. 1390 mm

Versione MAGNUM

H. 725 mm  
P. 550 mm  
L. 1390 mm



Per piani da l. 1400 mm a l.2400 mm x 900-1000 mm  
*For tops from l. 1400 mm to l.2400 mm x 900-1000 mm*

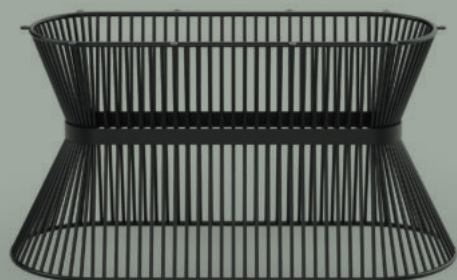

Per piani da l. 2200 mm a l. 3000 mm x 900-1000 mm /  
*For tops from l. 2200 mm to l. 3000 mm x 900-1000 mm*





# Plaza

Tavolo smontabile  
in tubo 40x40x1.5 mm  
Con piano in lamiera

## Finiture

Verniciato per interni  
Verniciato per esterni con doppio  
trattamento

## Optional

Versione tutta saldata su richiesta

## Misure

700x700 h. 760 mm

800x800 h. 760 mm

900x900 h. 760 mm

H. gambe 1100 mm su richiesta

*Detachable table in tube 40x40x1.5 mm  
With metal sheet top*

## Finishing

*Painted for indoor use  
Painted for outdoor use with double  
treatment*

## Optional

*All welded table version on demand*

## Measures

*700x700 - H. 760 mm*

*800x800 - H. 760 mm*

*900x900 - H. 760 mm*

*H. legs 1100 mm on demand*



Con piano 800x800 mm  
*With top 800x800 mm*



# Creta

Gambe in tubo conificato 50x50 mm  
sp. 2 mm  
Con piastra superiore sp. 3 mm e  
piedino regolabile

## **Finiture**

Verniciato

## **Optional**

Piani su richiesta  
Kit gambe da 3 pezzi  
Kit gambe da 4 pezzi

## **Misure**

H. gamba singola 723 mm o 673 mm  
Per piani d.800 mm / d. 1200 mm  
/ 800x800 mm / 800x1400 mm /  
900x1600 mm

*Legs in conic tube 50x50 mm  
th. 2 mm  
With upper plate th.3 mm and  
adjustable foot*

## **Finishing**

*Painted*

## **Optional**

*Tops on demand  
Kit of 3 legs  
Kit of 4 legs*

## **Measures**

*H. single leg 723 mm or 673 mm  
For tops d.800 mm / d. 1200 mm  
/ 800x800 mm / 800x1400 mm /  
900x1600 mm*



# Itaca

Gamba in tubo rettangolare 60x30  
Con piedini regolabili

## Finiture

Inox Aisi 304 satinato  
Ferro verniciato nero ral 9005

## Optional

Piano in legno su richiesta

## Misure (L.x H. mm)

380x932  
620x710  
900x710  
620x903  
900x903

*Leg in rectangular tube 60x30  
With adjustable feet*

## Finishing

*Brushed Inox Aisi 304  
Black painted ral 9005*

## Optional

*Wooden top on demand*

## Measures (L.x H. mm)

*380x932  
620x710  
900x710  
620x903  
900x903*

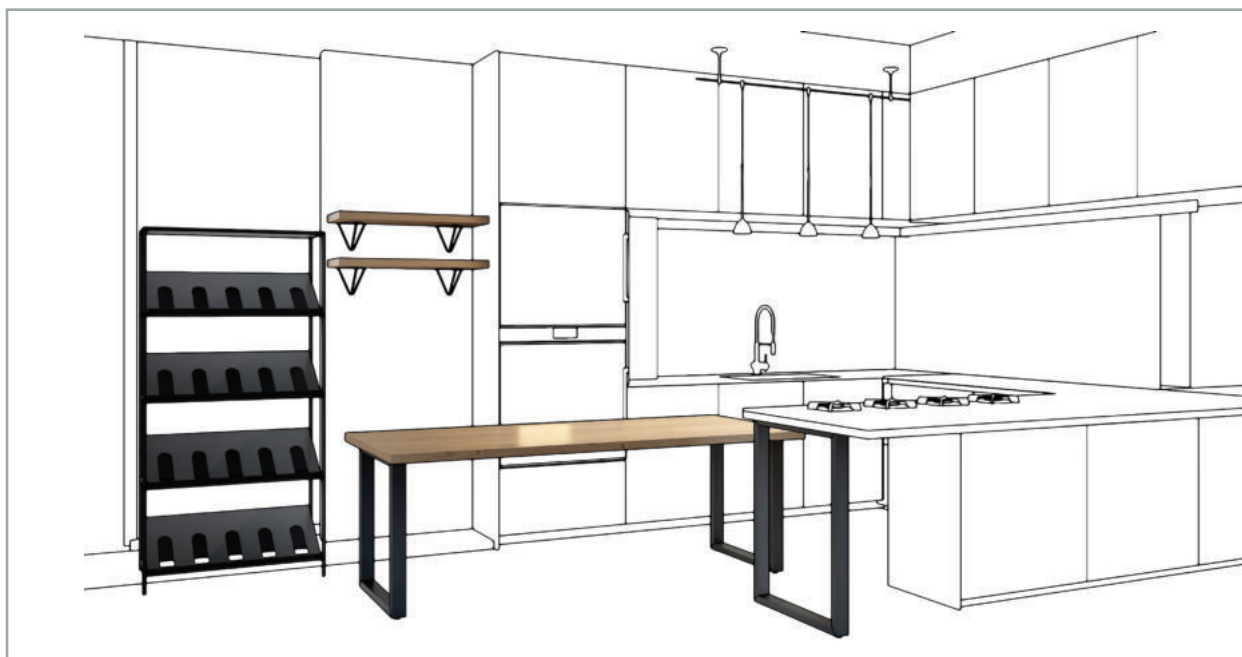

# Corfu

Gamba in tondino d.12 mm  
Con piedino regolabile

## Finiture

Verniciata nero ral 9005 o bianco ral 9010 opaco liscio

## Optional

Piano in legno su richiesta

## Misure

H. 710 mm o 905 mm

*Leg in wire d.12 mm  
With adjustable foot*

## Finishing

*Painted in black ral 9005 or white ral 9010 matt and smooth*

## Optional

*Wooden top on demand*

## Measures

*H. 710 mm or 905 mm*

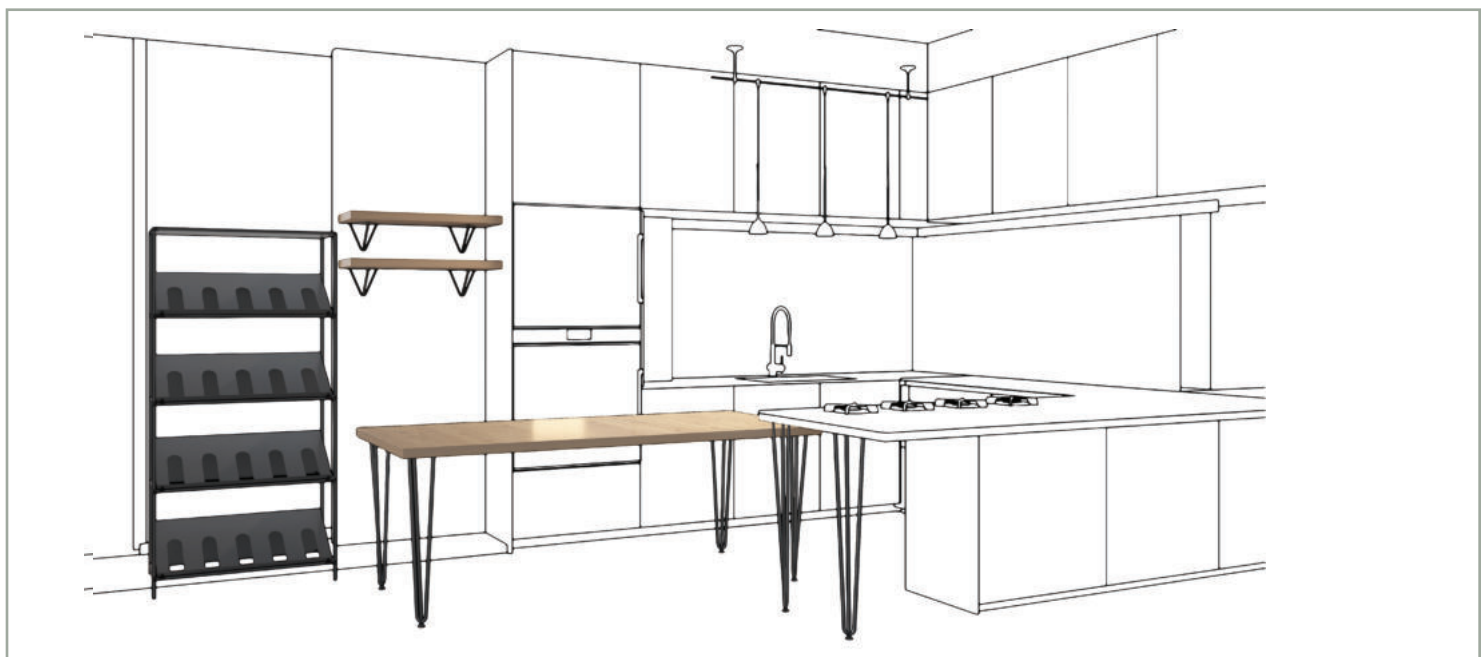

# Zante

Gamba in tubo rettangolare 60x40 mm  
Con lama superiore e piedini regolabili

*Leg in rectangular tube 60x40 mm  
With upper plate and adjustable feet*

## **Finiture**

Verniciata nero ral 9005 o bianco ral 9010 opaco liscio

## **Finishing**

*Black painted ral 9005 or white ral 9010 matt and smooth*

## **Optional**

Piano in legno su richiesta

## **Optional**

*Wooden top on demand*

## **Misure**

H. 710 mm o 903 mm  
L. 780 mm

## **Measures**

*H. 710 mm or 903 mm  
L. 780 mm*







# Class 40

Tavolo fisso con longheroni 50x20 sp.  
1,5 mm  
Gambe smontabili d.40x2 mm  
Componibile e fornito in kit di  
componenti

## Finiture

Cromato  
Verniciato

## Optional

Piano in vetro temperato  
Piano in legno

## Misure

Da: 70 x 70 mm  
A: 800 x 2000 mm  
H 750 mm

*Fixed table frame metal struts 50 x 20  
mm thickness 1,5 mm  
Detachable legs d.40x2 mm  
Modular table , supplied in kit of  
components*

## Finishing

*Chromed  
Painted*

## Optional

*Tempered glass top  
Wooden top*

## Measures

*From: 70 x 70 mm  
To: 800 x 2000 mm  
H 750 mm*

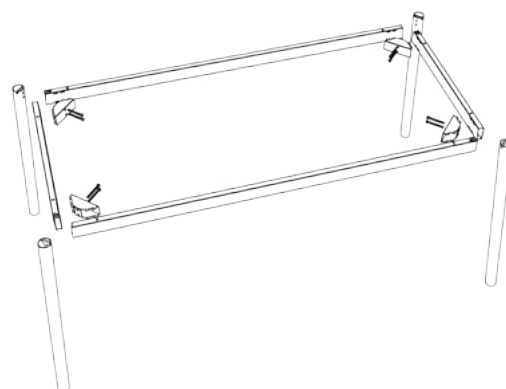

# Class

Telaio fisso longheroni 50 x 20 mm  
spess. 1,5 mm  
Gambe smontabili 50 x 20mm  
spess. 1,5 mm  
Componibile

## Finiture

Cromato  
Verniciato

## Optional

Ripiano in vetro temperato  
Ripiano in legno

## Misure

Da: 70 x 70 mm  
A: 800 x 2000 mm  
H 750 mm

*Fixed table frame metal struts 50 x 20 mm  
thickness 1,5 mm  
Detachable legs 50 x 20 mm  
thickness 1,5 mm  
Modular*

## Finishing

*Chromed  
Painted*

## Optional

*Tempered glass top  
Wooden top*

## Measures

*From: 70 x 70 mm  
To: 800 x 2000 mm  
H 750 mm*



# Apollo

Tavolo 1500×900 con doppia allunga  
50+50 cm con gambe coniche ad  
angolo rinforzate

## Finiture

Verniciato  
Guide in alluminio

## Optional

Piano su richiesta

## Misure

H 760 mm  
P 900 mm  
L 1500 mm – 2000 mm – 2500 mm

*Table 1500×900 with double extension  
50+50 cm with reinforced conic legs*

## Finishing

*Painted  
Alluminium guide*

## Optional

*Top on demand*

## Measures

*H 760 mm  
P 900 mm  
L 1500 mm – 2000 mm – 2500 mm*

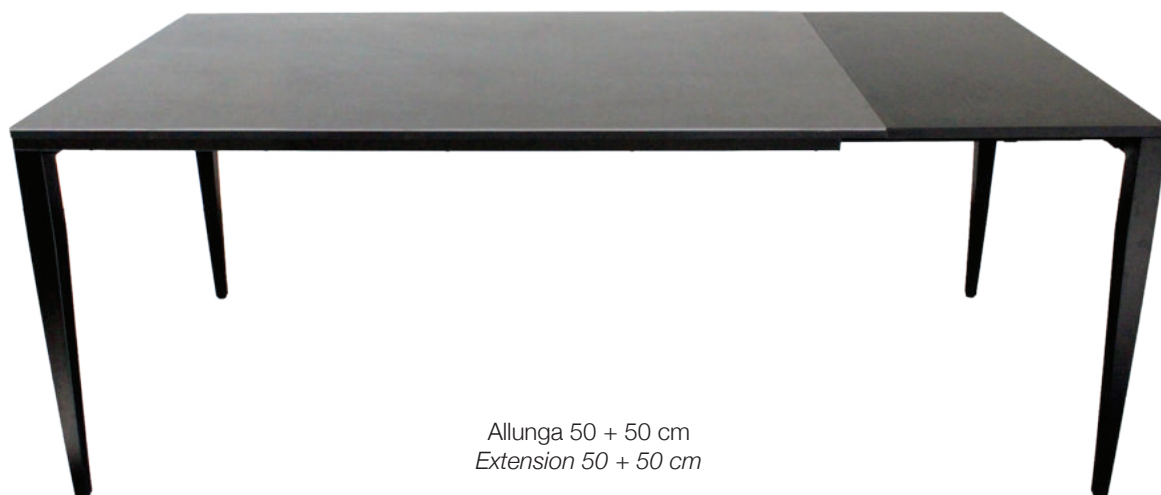

Allunga 50 + 50 cm  
Extension 50 + 50 cm



# Babylon

Prodotto registrato n. 004066900  
Gamba singola in tondino d. 12 mm con  
lama per piano in vetro o piano in legno

## Finiture

Cromato  
Verniciato  
Verniciato per esterni con trattamento ai  
Sali di zinco

## Optional

Traversi di rinforzo di varie misure su  
richiesta  
Piano in legno  
Piano in vetro

## Misure

H 730 mm  
P 400 mm  
L 747 mm

*Registered product n. 004066900  
Single leg in wire d. 12 mm with plate for  
glass top or wooden top*

## Finishing

*Chromed  
Painted  
Painted for outdoor use with  
zinc powder treatment*

## Optional

*Reinforcement bars in different dimen-  
sions on demand  
Wooden top  
Tempered glass top*

## Measures

*H. 730 mm  
P. 400 mm  
L. 747 mm*

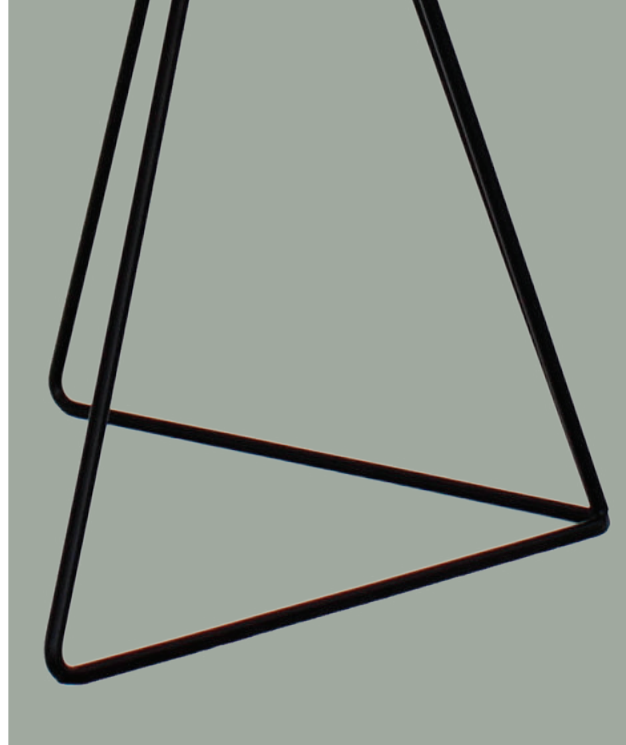

# Riga

Telaio allungabile  
Longheroni 50 x 20 mm  
spess. 1,5 mm  
Gambe 50 x 50 mm – H 735 mm

## **Finiture**

Verniciato nero  
Verniciato bianco  
Verniciato grigio

## **Optional**

Piano in legno

## **Misure**

700 x 1150 mm  
800 x 1200 mm  
800 x 1400 mm  
800 x 1600 mm  
800 x 1800 mm  
Allunga 500 mm

*Extendable table frame  
Metal struts 50 x 20 mm  
thickness 1,5 mm  
Legs 50 x 50 mm – H 735 mm*

## **Finishing**

*Black painted  
White painted  
Grey painted*

## **Optional**

*Wooden top*

## **Measures**

*700 x 1150 mm  
800 x 1200 mm  
800 x 1400 mm  
800 x 1600 mm  
800 x 1800 mm  
Extension 500 mm*



# Rodi

Telaio fisso  
Longheroni 50 x 20 mm  
spess. 1,5 mm  
Gambe 50 x 50 mm  
H. 735 mm

## Finiture

Verniciato nero  
Verniciato bianco  
Verniciato grigio

## Optional

Gambe coniche ad angolo rinforzate  
come mod. APOLLO  
Piano in legno

## Misure

800 x 800 mm  
800 x 1200 mm  
800 x 1400 mm  
800 x 1600 mm  
800 x 1800 mm

*Fixed frame  
Metal struts 50 x 20 mm  
th. 1,5 mm  
Legs 50 x 50 mm  
H. 735 mm*

## Finishing

*Black painted  
White painted  
Grey painted*

## Optional

*Reinforced conic legs as mod. APOLLO  
Wooden top*

## Measures

*800 x 800 mm  
800 x 1200 mm  
800 x 1400 mm  
800 x 1600 mm  
800 x 1800 mm*



# Tropea Wood

Telaio in tondino d.11 mm  
Gambe coniche in legno

## **Finiture**

Telaio cromato o verniciato  
Gambe in legno faggio naturale,  
frassino naturale o tinto noce

## **Optional**

Ripiano in legno

## **Misure**

H. 720 mm  
P. 558 mm  
L. 559 mm

*Frame in wire d. 11 mm  
Conic wooden legs*

## **Finishing**

*Chromed or painted frame  
Wooden legs in natural beech,  
natural ash or painted in nut colour*

## **Optional**

*Wooden top*

## **Measures**

*H. 720 mm  
P. 558 mm  
L. 559 mm*





# Hide / Hide Q

Kit di due gambe pieghevoli  
In tubo tondo d.28 x 2 mm (mod. Hide)  
In tubo quadro 40x40 mm (mod. Hide Q)

## Finiture

Cromato (solo per la versione Hide)  
Verniciato

## Optional

Piano in legno su richiesta  
Supporto di rinforzo per piani l. 1600-1800 mm  
Per Hide Q : versione con o senza lamiera coprente laterale

## Misure

H. 700 mm senza piano  
P. piano : 800 mm  
L. piano: 1200 - 1400 - 1600 - 1800 mm  
L. gambe: 657 mm  
Altre misure del piano su richiesta

*Kit of two folding legs  
In round tube d.28 x 2 mm (mod. Hide)  
In square tube 40 x 40 mm (mod. Hide Q)*

## Finishing

*Chromed (only for mod. Hide)  
Painted*

## Optional

*Wooden top on demand  
Reinforcement beams for tops l. 1600-1800 mm  
For mod. Hide Q: version with or without lateral covering metal sheets*

## Measures

*H. 700 mm without top  
P. top : 800 mm  
L. top: 1200 - 1400 - 1600 - 1800 mm  
L. legs: 657 mm  
Other measures of the top on customer's demand*



# Burano

Tavolo con base Burano a 3 fori,  
d. 680 mm  
Abbinabile a colonne di varie misure  
Con piastra reggipiano 250x250 mm

## **Finiture**

Cromato  
Verniciato

## **Optional**

Con piedini regolabili o puntali standard

## **Misure**

colonna l. 520 mm -> h. totale da terra  
senza piedini a fine piastra: 720 mm  
colonna l. 840 mm -> h. totale da terra  
senza piedini a fine piastra: 1040 mm

Alte misure su richiesta

*Table with Burano base with 3 holes,  
d. 680 mm  
It can match columns with different lengths  
With upper plate 250x250 mm*

## **Finishing**

*Chromed  
Painted*

## **Optional**

*With adjustable glides or standard glides*

## **Measures**

*column l. 520 mm -> total height from the  
ground to the end of the plate: 720 mm  
column l. 840 mm -> total height from the  
ground to the end of the plate: 1040 mm*

*Other measures on demand*



# Pisa T

Telaio in tondino Ø 12 mm  
base Ø 470 mm  
Due altezze disponibili

## Finiture

Cromato  
Verniciato

## Optional

Piano in lamiera  
Piano in vetro  
Piano in legno  
Piano in Hyrek

## Misure

H 740 / 1100 mm  
Top D.600 – D.800 mm

*Frame wire Ø 12 mm  
base Ø 470 mm  
Two heights available*

## Finishing

*Chromed  
Painted*

## Optional

*Metal sheet top  
Glass top  
Wooden top  
Hyrek top*

## Measures

*H 740 / 1100 mm  
Top D.600 – D.800 mm*

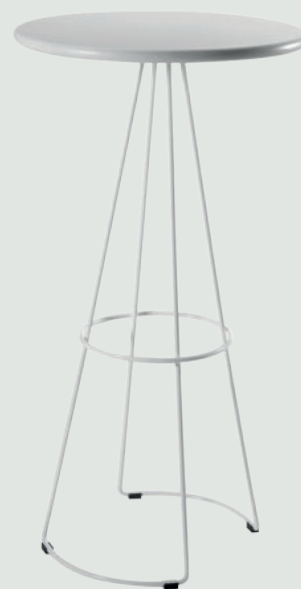

Versione alta / High version



# Atlanta Quadro

Telaio fisso monogamba  
Base Murano 390×390 / 470×470 /  
600×600  
Colonna quadra 50×50 / 60×60  
2 altezze disponibili

## Finiture

Cromato  
Verniciato

## Optional

Piano in legno  
Piano in vetro  
Crociera reggipiano in ghisa 420×420  
Base rettangolare 800×500 con due  
colonne per piani rettangolari

## Misure

H 725 / 1076 mm  
Top 600×600  
Top 700×700  
Top 800×800

*Fixed table, one-single leg  
Base Murano 390×390 / 470×470 /  
600×600  
Squared column 50×50 / 60×60  
2 heights available*

## Finishing

*Chromed  
Painted*

## Optional

*Wooden top  
Glass top with related plate  
Black cast iron plate 420×420  
Rectangular base 800×500 with two  
columns for rectangular tops*

## Measures

*H 725 / 1076 mm  
Top 600×600  
Top 700×700  
Top 800×800*



Con base rettangolare / With rectangular base



# Atlanta Tondo

Telaio fisso monogamba  
Base Lido d.390 / d.470 / d.600 / d.750  
Colonna tonda d.50 / d.60 / d.76 mm  
2 altezze disponibili

## Finiture

Cromato  
Verniciato

## Optional

Piano in legno  
Piano in vetro  
Crociera reggipiano in ghisa 420x420

## Misure

H. 725 / 1076 mm  
Top d.600  
Top d.700  
Top d.800

*Fixed table, one-single leg*

*Base Lido d.390 / d.470 / d.600 / d.750*

*Round column d.50 / d.60 / d.76 mm*

*2 heights available*

## Finishing

*Chromed  
Painted*

## Optional

*Wooden top  
Glass top  
Black cast iron plate 420x420*

## Measures

*H. 725 / 1076 mm  
Top d.600  
Top d.700  
Top d.800*



# Atlanta Qr

Telaio regolabile in altezza  
Colonna 50x50/60x60mm – carica  
alzata 200N

**Finiture**  
Cromato

**Optional**  
Alzata con blocco idraulico h. 680 /  
1080 mm  
Piastra reggipiano standard 170x170  
con leva e spatola nera  
Piastra reggipiano 250x250 con  
blocchetto estetico e leva  
Piano in legno su richiesta

**Misure**  
h. 475 / 734 mm con piastra standard  
h. 467 / 728 mm con blocchetto  
estetico  
h. 740 / 1006 mm con piastra standard  
h. 740 / 1003 mm con blocchetto  
estetico

*Adjustable height frame  
Column 50x50/60x60mm – power  
200N*

**Finishing**  
*Chromed*

**Optional**  
*Adjustable height with hydraulic block h.  
680 / 1080 mm  
Standard plate for top 170x170 with  
lever and black paddle  
Plate for top 250x250, with aesthetical  
join and lever  
Wooden top on demand*

**Measures**  
*h. 475/734 mm with standard plate  
h. 467/728 mm with aesthetical join  
h. 740/1006 mm with standard plate  
h. 740/1003 mm with aesthetical join*

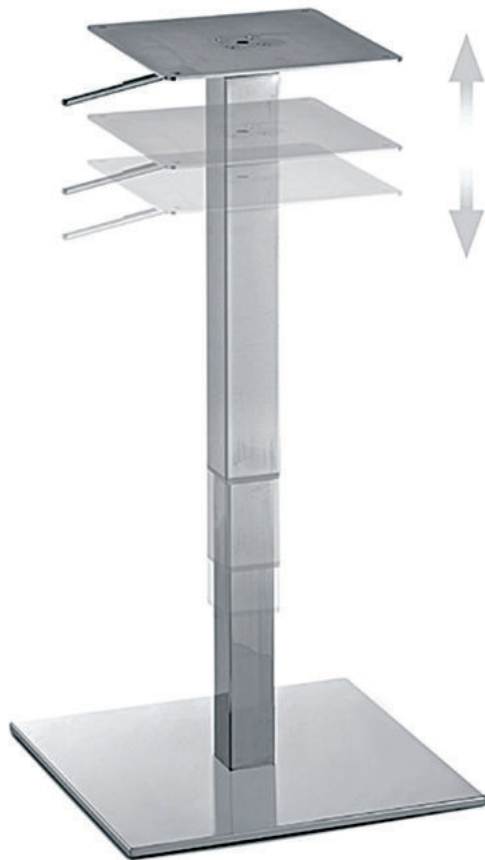

Attacco con blocchetto estetico  
*With aesthetical join*

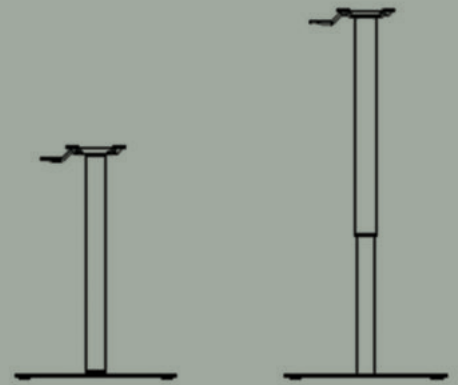

Versione pranzo  
ATLANTA ALTO CHIUSO

Versione bar  
ATLANTA ALTO APERTO

*Lunch Version  
HIGH ATLANTA CLOSED*

*Bar version  
HIGH ATLANTA OPEN*

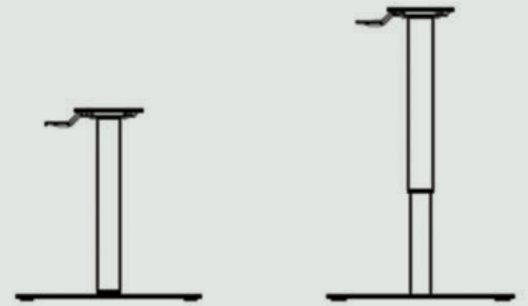

Versione Caffè  
ATLANTA BASSO CHIUSO

Versione pranzo  
ATLANTA BASSO APERTO

*Coffee Version  
LOW ATLANTA CLOSED*

*Lunch version  
LOW ATLANTA OPEN*

Opzioni piastre / *Plates options:*



Piastra OMS  
OMS Plate



Piastra con blocchetto estetico  
*Plates with aesthetical join*

TAVOLINI  
*COFFEE TABLES*





# Elegant

Telaio fisso con base d.300 sp.4 mm  
Colonna d.30 h. 400 mm o 500 mm

## Finiture

Verniciato nero ral 9005 / bianco ral 9010 / grigio ral 7030  
Altri colori su richiesta

## Optional

Piano in legno nobilitato, laccato o laminato  
Piano in HPL

## Misure

H. 400 o 500 mm  
D. base 300 mm

*Fixed table with base d.300 th.4 mm  
Column d.30 h.400 mm or 500 mm*

## Finishing

*Painted in black ral 9005 / white ral 9010 / grey ral 7030  
Other colours on demand*

## Optional

*Chipboard, lacquered or laminated  
wooden top  
HPL top*

## Measures

*H. 400 or 500 mm  
D. base 300 mm*





# Parvus 800

Struttura tavolino in tondino  
d.11 mm e tondini verticali ø 5 mm  
Anelli d. 800 mm

## Finiture

Verniciato nero ral 9005 / bianco ral  
9010 / bronzo

## Optional

Piano in legno, vetro o grès

## Misure

D. 800 mm  
H. 350 mm

*Coffee table in wire  
d.11 mm and vertical wires ø 5 mm  
Rings d. 800 mm*

## Finishing

*Black painted ral 9005 / white ral 9010  
/ bronze*

## Optional

*Wooden top, glass top or stoneware*

## Measures

*D. 800 mm  
H. 350 mm*

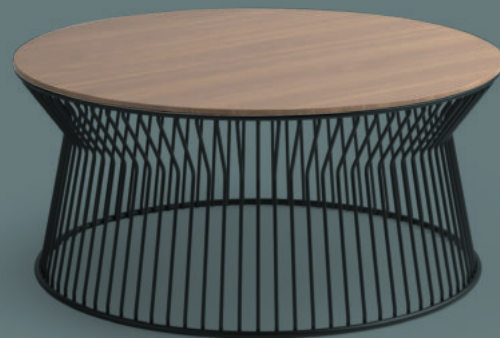



# Parvus 500

Struttura tavolino Parvus in tondino  
d. 11 mm e tondini verticali  $\varnothing$  5 mm

Anello d.500 mm

## Finiture

Verniciato nero ral 9005 / bianco ral  
9010 / bronzo

## Optional

Piano in legno, vetro o grès

## Misure

D. 500 mm  
H. 400 mm

*Coffe table Parvus in wire  
d.11 mm and vertical wires  $\varnothing$  5 mm*

*Ring d. 500 mm*

## Finishing

*Black painted ral 9005 / white ral 9010  
/ bronze*

## Optional

*Wooden top, glass top or stoneware top  
on demand*

## Measures

*D. 500 mm  
H. 400 mm*



# Cruz

Struttura in tondino d.11 mm,  
d. 800 mm

## **Finiture**

Verniciato nero ral 9005 /  
bianco ral 9010

## **Optional**

Piano in HPL su richiesta  
Piano in poliestere riciclato su richiesta

## **Misure**

D. 800 mm  
H. 350 mm

Frame in wire d.11 mm,  
d.800 mm

## **Finishing**

*Black painted ral 9005 /  
white ral 9010*

## **Optional**

HPL top on demand  
Recycled polyester top on demand

## **Measures**

*D. 800 mm  
H. 350 mm*

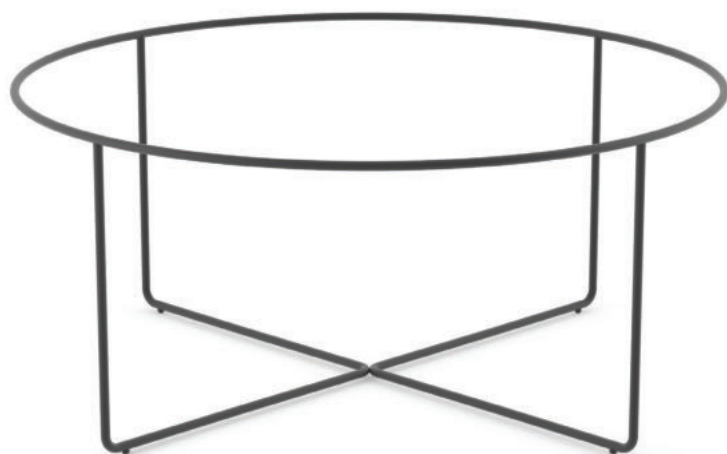

Dettaglio ripiano in poliestere riciclato  
Detail of recycled polyester top



# Tulum

Struttura in tondino  
d. 12 mm

## Finiture

Verniciato nero ral 9005  
Ferro cromato  
Black nickel

## Optional

Piano in vetro temperato sp. 10 mm a  
richiesta  
Piano in kerlite a richiesta

## Misure

d. 500 h. 450 mm  
d. 600 h. 350 mm  
d. 800 h. 300 mm

*Frame coffee table in wire  
d.12 mm*

## Finishing

*Black painted ral 9005  
Chromed  
Black nickel*

## Optional

*Tempered glass top th.10 mm on  
demand  
Top in kerlite on demand*

## Measures

*d. 500 h. 450 mm  
d. 600 h. 350 mm  
d. 800 h. 300 mm*

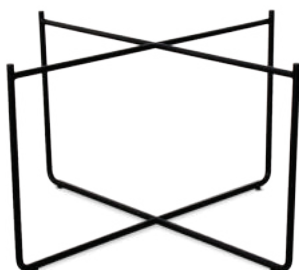
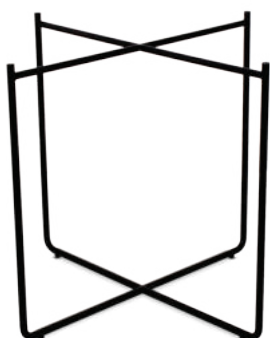
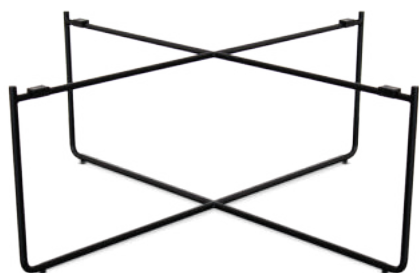





# Hawaii

Struttura in tondino  
d. 10 mm

**Finiture**

Verniciato  
Ferro cromato

**Optional**

Piano in lamiera  
Piano in kerlite

**Misure**

D 477 mm  
H. 400 mm

*Frame in wire  
d. 10 mm*

**Finishing**

*Painted  
Chromed*

**Optional**

*Metal top  
Kerlite top*

**Measures**

*D. 477 mm  
H. 400 mm*



Con piano in kerlite  
*With kerlite top*



Con piano in lamiera  
*With metal top*



# Zanzibar

Telaio in tondino Ø 12 mm

## Finiture

Cromato  
Verniciato

## Optional

Piano in legno  
Piano in vetro

## Misure

H 400 mm  
P 500 mm  
L 700 mm

Frame wire Ø 12 mm

## Finishing

Chromed  
Painted

## Optional

Wooden top  
Glass top

## Measures

H 400 mm  
P 500 mm  
L 700 mm



# Malindi

Telaio in tubo Ø 20 mm  
Anello da Ø 20 mm

## Finiture

Cromato

## Optional

Piano in legno  
Piano in vetro

## Misure

H 605 mm  
P Ø 480 mm  
L Ø 480 mm

*Frame tube Ø 20 mm  
Ring Ø 20 mm*

## Finishing

*Chromed*

## Optional

*Wooden top  
Glass top*

## Measures

*H 605 mm  
P Ø 480 mm  
L Ø 480 mm*



# Maya

Telaio in tubo Ø 20 mm  
2 altezze  
Vendibili in coppia

## Finiture

Cromato / Verniciato

## Optional

Piano in legno  
Versione smontabile

## Misure

800 x 950 x 770 mm  
560 x 810 x 850 mm  
H. 370 mm – 430 mm

*Frame tube Ø 20 mm  
2 heights  
To be sold in couple*

## Finishing

*Chromed / Painted*

## Optional

*Wooden top  
Detachable version*

## Measures

*800 x 950 x 770 mm  
560 x 810 x 850 mm  
H. 370 mm – 430 mm*



LIBRERIE  
*BOOKCASES*

# D.13

Tubetti in tondino d.13 mm  
Inserti di fissaggio a 3/4/5/6 braccia, a  
L / X / T  
Varie composizioni possibili

## Finiture

Telaio cromato  
Telaio verniciato nero / bianco  
Telaio ramato lucido  
Telaio ottonato Lucido  
Mensole, schienali e fianchi in legno  
rovere naturale / noce / laminato bianco  
o nero

## Optional

Piedini regolabili h.60 mm / 80 mm  
Ripiano in lamiera portaoggetti o  
portabottiglie  
Ante in legno  
Mensola porta vaso

## Misure

A seconda della composizione scelta  
Misure tubetti: l. 60 mm / 80 mm / 237  
mm / 331 mm / 381 mm / 529 mm /  
781 mm  
Misure piani possibili: mm 780x780  
/ 780x380 / 780x330 / 780x238  
/ 530x380 / 530x330 / 380x380 /  
380x330 / 380x238 / 330x330 /  
330x238

Visita il nostro configuratore online:



*Tubes in wire d.13 mm  
Inserts with 3/4/5/6 arms, at L / X / T  
shape to join the tubes  
Different possible compositions*

## Finishing

*Chromed frame  
Black / white painted frame  
Bright copper frame  
Bright brass frame  
Wooden tops (shelves, backrests, side  
panels) in natural oak / walnut / black and  
white laminated*

## Optional

*Adjustable feet h.60 mm / 80 mm  
Metal top to display objects or bottles  
Swing wooden doors  
Top as vase holder*

## Measures

*Depending on the chosen composition  
Tubes measures: l. 60mm / 80mm /  
237mm / 331mm / 381mm / 529mm /  
781mm  
Tops available: mm 780x780 / 780x380  
/ 780x330 / 780x238 / 530x380  
/ 530x330 / 380x380 / 380x330 /  
380x238 / 330x330 / 330x238*

Visit our online configurator:

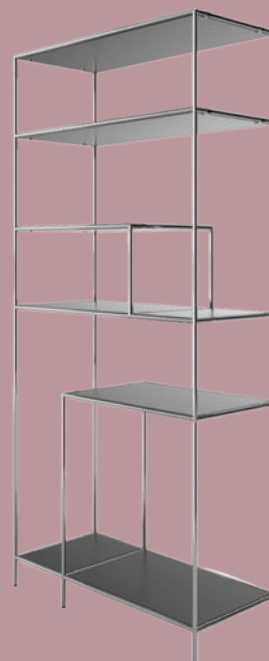

# Cuba

Telaio in tondino Ø 11 mm  
Accatastabile a colonna

## Finiture

Verniciato  
Cromato

## Optional

Lamiera verniciata  
Piano in legno

## Misure

400 x 380 mm  
L 400 Top  
L 1200 Top  
L 2000 Top  
L 2400 Top  
I piani spess. 50 mm

*Frame in wire Ø 11 mm  
Stackable as a column*

## Finishing

*Chromed  
Painted*

## Optional

*Painted metal sheet  
Wooden top*

## Measures

*400 x 380 mm  
L 400 Top  
L 1200 Top  
L 2000 Top  
L 2400 Top  
Thickness top: 50 mm*



COMPLEMENTI  
D'ARREDO  
*ACCESSORIES*



# Appendino Camillo

## Hat-stand Camillo

Telaio in tubo da Ø 50 mm  
Tutto smontabile

### Finiture

Cromato  
Verniciato  
Plastiche e base nera

### Misure

H 1800mm Ø 420mm  
Box: 510x425x125 mm

*Frame tube Ø 50mm  
Jointable*

### Finishing

*Chromed  
Painted  
Black plastics and base*

### Measures

*H 1800mm Ø 420mm  
Box: 510x425x125 mm*

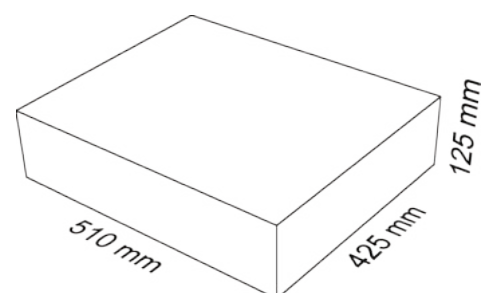



# Appendino Tipi

## Hat-stand Tipi

Struttura in tubo d.25x1.5 mm

### Finiture

Verniciato nero ral 9005 /  
bianco ral 9010  
Altri colori su richiesta

### Optional

Terminali in legno faggio verniciato  
naturale o tinto noce

### Misure

H. 1656 mm  
L. 529 mm  
P. 462 mm

Frame in tube d.25x1.5 mm

### Finishing

Black painted ral 9005 /  
white ral 9010  
Other colours on demand

### Optional

Ends of the tubes in natural beechwood  
or walnut painted

### Measures

H. 1656 mm  
L. 529 mm  
P. 462 mm

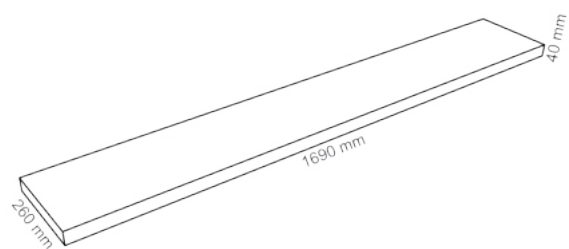

# Appendino Ego

## *Hat-stand Ego*

Appendino in tubo ovale  
40x20x1.5 mm,  
tutto smontato  
Traverso in tubo ovale cromato  
Cappelliera d.6 mm  
2 porta-ombrelli con vaschetta

### **Finiture**

Verniciato nero opaco liscio ral 9005  
Cappelliera e traverso cromati

### **Misure**

H. 1700 mm  
P. 405 mm  
L. 645 mm

*Hat-stand in oval tube  
40x20x1.5 mm,  
all not assembled  
Central oval beam, chromed  
Hatbox d.6 mm  
Two umbrella-stands with bowl*

### **Finishing**

*Black painted ral 9005  
Chromed hatbox and chromed central  
beam*

### **Measures**

*H. 1700 mm  
P. 405 mm  
L. 645 mm*

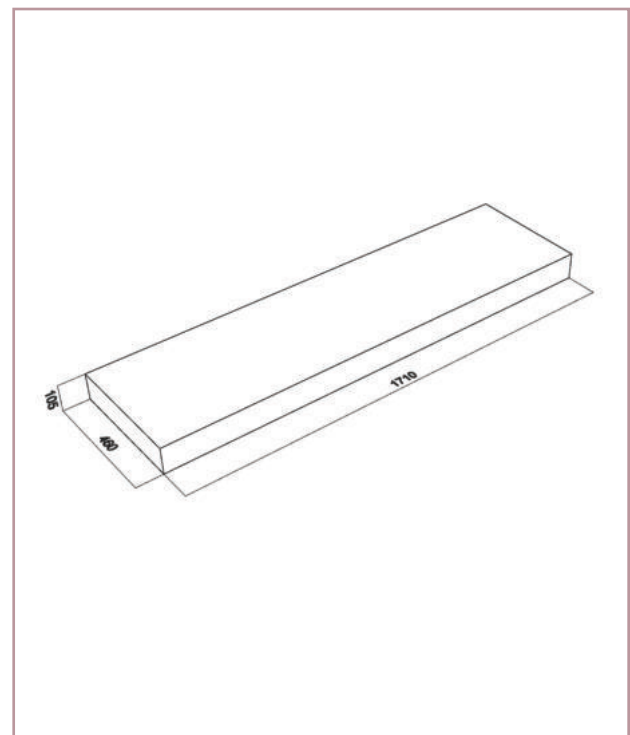

# Carrello Hide

## Trolley Hide

Struttura in tubo rettangolare 60x30 mm con 4 ruote girevoli di cui 2 con freno. Angolari rimovibili in tubo Ø 45 mm. Portata massima: 10 tavoli.

**Finiture**  
Verniciato

**Misure**  
H 1070 mm  
P 980 mm

Regolabile da l. 1390 mm a l. 1990 mm

*Structure in rectangular tube 60x30 mm with 4 swivel wheels whose 2 with brake. Removable angular supports in tube Ø 45 mm. Maximum capacity: 10 tables.*

**Finishing**  
*Painted*

**Measures**  
*H 1070 mm  
P 980 mm*

*Adjustable from l. 1390 mm to l. 1990 mm*



# Carrello Plus

## Trolley Plus

Telaio in tubo d.25 mm per sedie a impilaggio verticale e inclinate

### Finiture

Verniciato con manubrio regolatore cromato

### Misure

Minime tra gambe posteriori: 444 mm  
Massima tra gambe posteriori: 634 mm  
Minime tra gambe anteriori: 395 mm  
Massima tra gambe anteriori: 560 mm  
Profondità minima: 229 mm  
Profondità massima: 471 mm

*Frame in tube d.25 mm for vertically stackable chairs or inclined chairs*

### Finishing

*Painted frame with adjustable chromed handlebar*

### Measures

*Minimum between posterior legs: 444 mm  
Max. between posterior legs: 634 mm  
Minimum between anterior legs: 395 mm  
Max. between anterior legs: 560 mm  
Minimum depth: 229 mm  
Max. depth: 471 mm*



# Carrello Maciste

## Trolley Maciste

Struttura in tubo d.35x2 mm, maniglia d.28 mm con 4 ruote d. 100 mm frenanti

### Finiture

Verniciato nero ral 9005 gofrato

### Misure

H 849 mm  
P 784 mm  
L 926.5 mm

Per sedie a slitta impilabili

*Structure in tube d.35x2 mm, handle d.28 mm with 4 wheels d.100 mm with brake*

### Finishing

*Painted in black ral 9005 embossed*

### Measures

*H 849 mm  
P 784 mm  
L 926.5 mm*

*For stackable sled chairs*



# Portaombrelli

## *Umbrella stands*

### BETA

Portaombrelli in tubo d.20x1.5 mm  
Piastra 150x150x10 mm  
Vaschetta in ferro sp.1 mm

#### **Finiture**

Verniciato per interni  
Verniciato per esterni

#### **Misure**

H. 675 mm  
P. 165 mm  
L. 165 mm

*Umbrella stand in tube d.20x1.5 mm  
Plate 150x150x10 mm  
Metal bowl th. 1 mm*

#### **Finishing**

*Painted for indoor  
Painted for outdoor*

#### **Measures**

*H. 675 mm  
P. 165 mm  
L. 165 mm*





# GAMMA

Portaombrelli in tondino d.12 mm con  
vaschetta spessore 1 mm

## Finiture

Verniciato per interni  
Verniciato per esterni

## Misure

D. vaschetta 300 mm  
H. 646 mm  
L. 232 mm

*Umbrella stand in wire d.12 mm with  
metal bowl th. 1 mm*

## Finishing

*Painted for indoor  
Painted for outdoor*

## Measures

*D. bowl 300 mm  
P. 646 mm  
L. 232 mm*



# COMPONENTI COMPONENTS

# BASI / BASES

## Base Cork 4 razze *Cork Base 4 legs*

Base in lama spess. 12 mm,  
diagonale 650 - 750 mm H.  
da terra 55 mm  
Per colonne o alzate a gas d.  
50 mm, attacco a 3 fori  
Cromato - Verniciato

*Bladed base thickness 12 mm,  
diagonal 650-750 mm  
H. from ground 55 mm  
For column or gaslifts Ø 50mm,  
3 holes join  
Chromed - Painted*

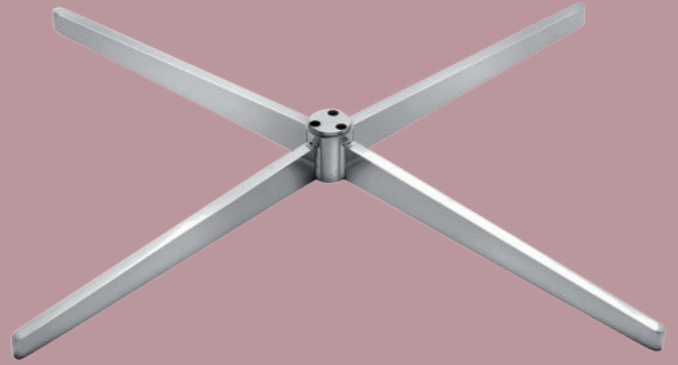

## Base Cork 5 razze *Cork Base 5 legs*

Base in lama spessore 12 mm  
Ø 650 mm  
Porta ruota o piedini M8  
Per colonne o alzate gas Ø 50  
mm attacco a 3 fori  
Cromato - Verniciato

*Bladed base thickness 12 mm,  
Ø 650 mm  
Adapters for castors or feet M8  
For columns or gaslifts Ø 50 mm,  
3 holes join  
Chromed - Painted*



## Base Elba *Elba Base*

In tubo d.22x2 mm  
h. 380 mm senza perno per tappi  
o portaruota  
Diagonale l. 700 mm  
Cromata o verniciata  
Optional: con perno girevole  
o con piastra girevole 165x165

*In tube d.22x2 mm  
h. 380 mm without pivot for caps  
or adapters for castors  
Diagonal l. 700 mm  
Chromed or painted  
Optional: with swivel pivot  
or with swivel plate 165x165*



## Base Elba C *Elba C Base*

In tubo d.22x2 mm conificato  
H. 390 mm senza perno con  
tappi montati  
Diagonale l. 700 mm  
Cromata - Verniciata  
Optional: con perno girevole  
o con piastra girevole 165x165

*With end-reduced tube  
d.22x2 mm  
H. 390 mm without pivot with  
assembled caps  
Diagonal l. 700 mm  
Chromed - Painted  
Optional: with swivel pivot  
or with swivel plate 165x165*





Base Burano  
*Burano Base*

Ø 680 mm  
H 280/320/360 mm senza perno  
Versione con perno girevole o  
versione con auto allineante  
Cromato - Verniciato

Ø 680 mm  
H 280/320/360 mm without pivot  
Version with swivel pivot or version  
with self-turning mechanism  
Chromed - Painted

Optional: portaruota

Optional: Adaptor for castors



Base Venezia  
*Venezia Base*

5 razze  
Ø 660 mm  
H 185 mm  
Portaruota Ø 11 mm  
Cromato - Verniciato

5 legs  
Ø 660 mm  
H 185 mm  
Adaptor for castors Ø 11 mm  
Chromed - Painted



Base Burano a 3 fori  
*Burano Base with 3 holes*

Ø 680 mm - Per tubi d.50 mm  
con 3 fori  
H. 195 mm senza piedini  
Cromato - Verniciato

Ø 680 mm - For tubes d.50 mm  
with 3 holes  
H. 195 mm without glides  
Chromed - Painted



Base Luna  
*Luna Base*

d.680 mm o d.640 mm in ferro  
cromato  
A 5 razze per cono d.50 mm  
In tubo semiovale  
Perno d.10 mm

d.680 mm or d. 640 mm  
chromed  
5 legs, cone d.50 mm  
Semi-oval tube  
Pin d.10 mm

Base Wood per gambe legno  
*Base Wood for wooden legs*

Per gambe in legno verniciata  
nera  
Inserto tubo 25x25  
A 5 razze per cono d.50 mm  
Perno d.11 mm

*For wooden legs, black painted*  
*Insert tube 25x25*  
*5 legs, cone d.50 mm*  
*Pin d.11 mm*



Base Marte  
*Marte Base*

d. 670 mm in alluminio  
A 4 razze per cono d.50 mm o  
d.40 mm  
H. 52 mm, con tappi a slitta

*d. 670 mm in alluminio*  
*4 legs, for tube d.50 mm*  
*or d.40 mm*  
*H. 52 mm, with caps*

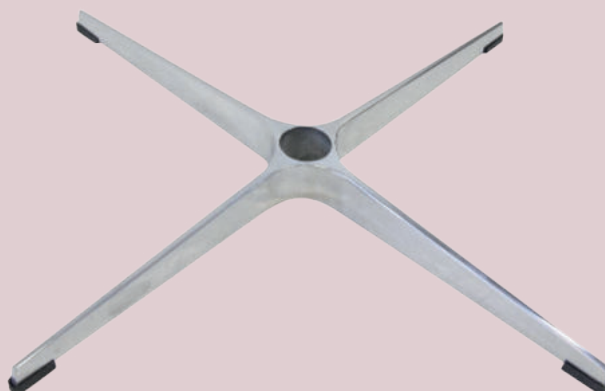

Base Mano  
*Mano Base*

In alluminio d. 700 mm  
A 5 razze per cono d.50 mm  
H. 88 mm

*In aluminium d.700 mm*  
*5 legs, cone d.50 mm*  
*H. 88 mm*



Base Giove  
*Giove Base*

In tubo ellittico  
Ferro cromato o verniciato  
d. 480/580/620 mm  
A 5 razze per cono d.50 mm  
Perno d.11 mm

*In elliptical tube*  
*Chromed iron or painted*  
*D. 480/580/620 mm*  
*5 legs, cone d.50 mm*  
*Pin d. 11 mm*



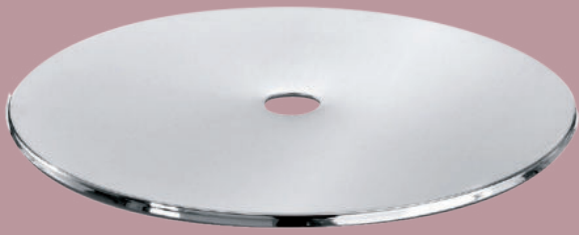

Base Lido  
*Lido Base*

Zincata + copertina inox AISI 430  
lucida o satinata  
Ø 390/425/470/600/750 mm  
Con Feltrini

*Galvanized + inox cover AISI 430  
shiny or glazed  
Ø 390/425/470/600/750 mm  
With felts*



Base Salina  
*Salina Base*

Zincata, sp. 8 mm con copertina  
Inox Aisi 430 lucida o satinata  
450x450 – altre misure a  
richiesta  
Con Feltrini

*Galvanized, Thickness 8mm  
with inox cover AISI 430 shiny or  
glazed  
450x450 – other measures on  
demand  
With felts*

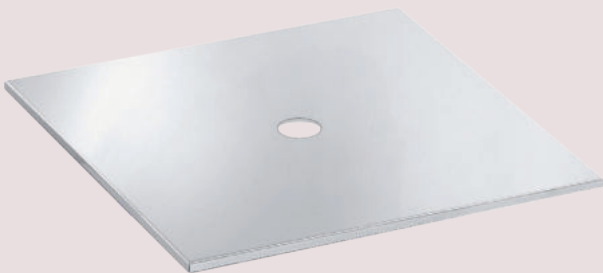

Base Murano  
*Murano Base*

Zincata + copertina inox AISI 430  
lucida o satinata  
Misure standard: 390x390 –  
470x470 – 600x600 mm  
Altre misure a richiesta  
Con Feltrini

*Galvanized + inox cover AISI 430  
shiny or glazed  
Standard measures: 390x390 –  
470x470 – 600x600 mm  
other measures on demand  
With felts*

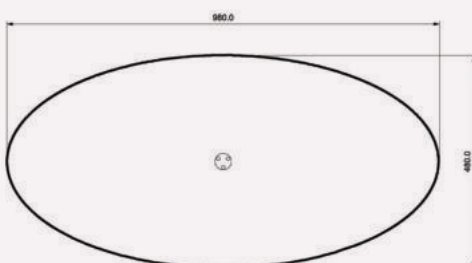

Base Ellipse  
*Ellipse Base*

Zincata + copertina Inox AISI 430  
lucida  
Misura standard: 980x480 mm  
Con Feltrini

*Galvanized + bright Inox cover AISI  
430 thickness 0,8 mm  
Standard measures: 980x480 mm  
With felts*

Base Rettangolare  
*Rectangular Base*

800x500 sp. 8 mm zincata  
Con copertina Inox lucido Aisi 430  
430  
Con fori per attacco di due colonne

*800x500 th.8 mm galvanized  
With Inox cover Aisi 430  
With holes for 2 columns*



Base a terra  
*Ground Base*

Piastra a terra per fissaggio a pavimento  
d. 200 mm sp. 8 mm zincata  
Con copertina Inox lucido Aisi 430 fornita non incollata, con foro centrale d.51 mm  
Attacco centrale a 3 fori M8  
Per colonne d. 50 mm

*Ground plate to be fixed to the floor  
d. 200 mm thick. 8 mm galvanized  
Inox cover AISI 430, supplied separately with central hole d.51 mm  
Central join with 3 holes M8  
For columns/ gaslifts d. 50 mm*

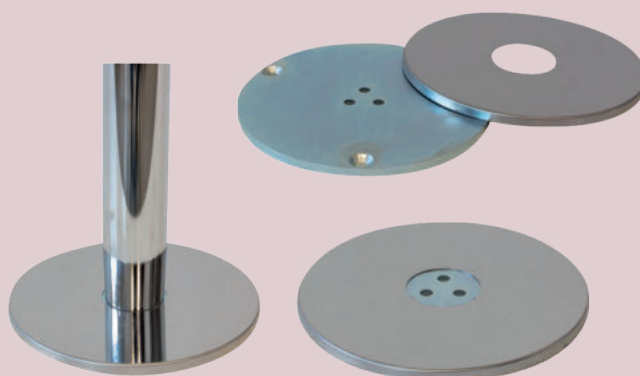

Base Campana  
*Campana Base*

Base con attacco conico per tubo d.50 mm:  
d. 440 mm  
d. 480 mm  
d. 580 mm  
Base con attacco a vite per tubo d.60 mm: d. 580 mm  
Cromata / Verniciata

*Base with conic join for tube d.50 mm:  
d. 440 mm  
d. 480 mm  
d. 580 mm  
Base with screw join for tube d.60 mm:  
d. 580 mm  
Chromed / Painted*



# COLONNE / COLUMNS

## Colonna girevole Compact Swivel column Compact

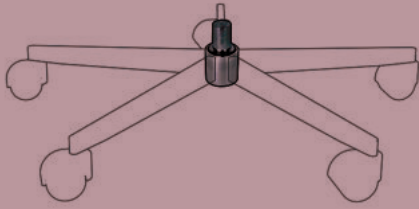

D.50 inferiore, h. 50 mm girevole  
su cuscinetto a secco conico  
d.28 standard superiore  
Cromata o verniciata

*D.50 conic in the inferior part, h.  
50 mm, swivel with dry bearing  
D.28 mm in the superior part  
Chromed or painted*

## Colonna autoallineante Compact Self-Turning column Compact

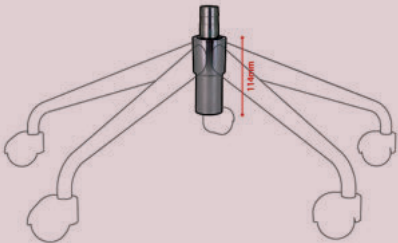

d.50 inferiore l. totale 114 mm  
girevole con autoallineante  
attacco conico d.28  
Cromata o verniciata

*d.50 in the inferior part; total  
length 114 mm  
standard conic join d.28 in the  
superior part with self-turning  
mechanism  
Chromed or painted*

## Colonna Girevole Attacco Conico Swivel column – Conic Join

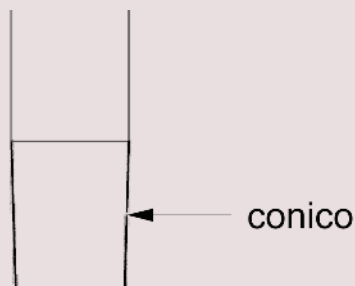

Ø 40/50  
L. 150 / 180 / 240 / 260 / 290 /  
310 / 345 / 420 / 690 mm  
Altre misure a richiesta  
Con perno girevole o  
autoallineante - Per piastra OMS  
Optional: boccia in alluminio  
con cuscinetto a secco e perno  
girevole su richiesta  
Cromata o verniciata

*Ø 40/50  
L. 150 / 180 / 240 / 260 / 290 /  
310 / 345 / 420 / 690 mm  
Other dimensions on request  
With swivel pivot or self-turning  
mechanism - For OMS plate  
Optional: aluminum join with  
dry bearing and swivel pivot on  
demand  
Chromed or painted*

## Colonna Girevole Attacco 3 Viti Swivel Column – 3 Screws Join

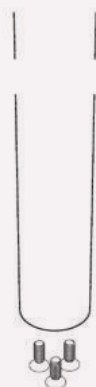

Ø 40/50  
L. 150 / 180 / 240 / 260 / 290 /  
310 / 345 / 420 / 690 mm  
Altre misure a richiesta  
Con perno girevole o  
autoallineante - Per piastra OMS  
Optional: boccia in alluminio con  
cuscinetto a secco  
e perno girevole su richiesta  
Cromata o verniciata

*Ø 40/50  
L. 150 / 180 / 240 / 260 / 290 /  
310 / 345 / 420 / 690 mm  
Other dimensions on request  
With swivel pivot or self-turning  
mechanism - For OMS plate  
Optional: aluminum join with dry  
bearing and swivel  
pivot on demand  
Chromed or painted*



Colonna Quadra Attacco 3 Viti  
*Square column – 3 screws join*

Tubo quadrato 50x50 mm  
 L. 150 / 180 / 240 / 260 / 290 /  
 310 / 345 / 420 / 690 mm  
 Con perno girevole o  
 autoallineante - Per piastra OMS  
 Cromata o verniciata

*Square tube 50x50 mm  
 L. 150 / 180 / 240 / 260 / 290 /  
 310 / 345 / 420 / 690 mm  
 With swivel pivot or self-turning  
 mechanism - For OMS plate  
 Chromed or painted*



Colonna con boccia alluminio  
*Column with alluminium join*

Colonna con boccia in alluminio  
 e cuscinetto a secco con perno  
 girevole  
 D. 50 mm  
 Attacco conico o a 3 viti  
 Boccia prevista obbligatoria per  
 tutte le misure inferiori a l. 150  
 mm, (misure su richiesta cliente).  
 Misure standard  
 L. 150 / 180 / 240 / 260 / 290 /  
 310 / 345 / 420 / 690  
 Cromata o verniciata

*Column with alluminium join and  
 dry bearing with swivel pivot  
 D. 50 mm - Conic or 3 screws  
 join  
 Alluminium join is put in all  
 measures less than l. 150 mm  
 (measures on customer's  
 demand).  
 Standard measures:  
 L. 150 / 180 / 240 / 260 / 290 /  
 310 / 345 / 420 / 690  
 Chromed or painted*

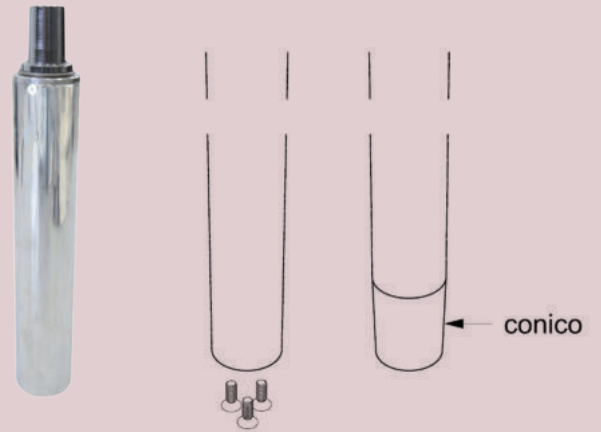

Colonna girevole con piastra Dover  
*Swivel column with Dover plate*

Colonna girevole con piastra  
 Dover 165x165  
 Tubo d.50 mm  
 Attacco inferiore conico o a 3 viti  
 Con boccia in alluminio per  
 colonne di misura inferiore a l.  
 150 mm  
 Misure standard:  
 L. 150 / 180 / 240 / 260 / 290 /  
 310 / 345 / 420 / 690 mm  
 Cromata o verniciata con piastra  
 sempre e solo cromata

*Swivel column with Dover plate  
 165x165  
 Tube d.50 mm  
 Inferior conic join or 3 screws join  
 With alluminium join for measures  
 less than 150 mm  
 Standard measures:  
 L. 150 / 180 / 240 / 260 / 290 /  
 310 / 345 / 420 / 690 mm  
 Chromed or painted with chro-  
 med plate in both versions*

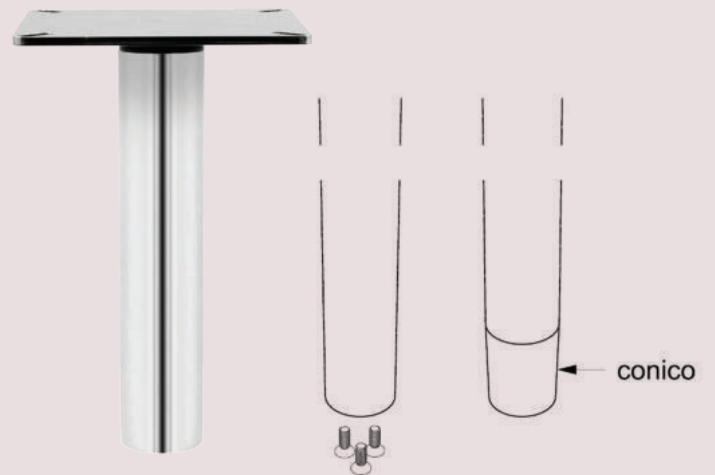

# ALZATE A GAS GASLIFTS

Molla a gas attacco conico  
*Gas spring conic join*

D.50 mm  
Per poltrona: l. 240/290 mm  
Per sgabello: l. 420 mm  
Cromata o verniciata

*D.50 mm  
For armchair: l. 240/290 mm  
For stool: l. 420 mm  
Chromed or painted*

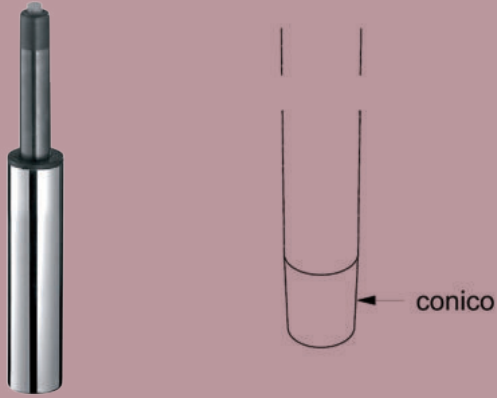

Molla a gas attacco 3 viti  
*Gas spring 3 screws join*

d.40/50 mm  
Per poltrona: l. 240/290 mm  
Per sgabello: l. 420 mm  
Cromata o verniciata

*D. 40 / 50 mm  
For armchair: l. 240/290 mm  
For stool: l. 420 mm  
Chromed or painted*

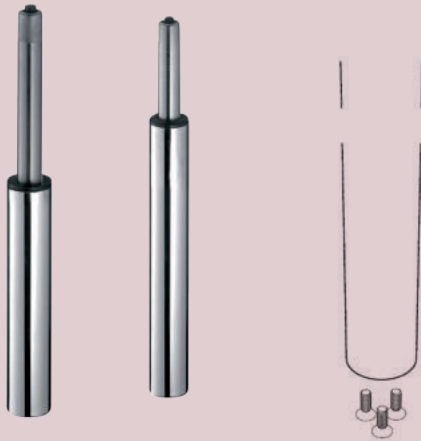

Molla a gas per poltrona attacco conico intermedio  
*Gas spring for armchair + middle conic join*

L: 230 mm – Ø 50 mm  
Cromata o verniciata

*L: 230 mm – Ø 50 mm  
Chromed or painted*



Molla quadra 50x50 - attacco a 3 viti  
*Square gas spring 50x50 - 3 screws join*

per poltrona L 240/290 mm  
per sgabello L 420 m  
Cromata o verniciata

*For armchair L 240/290 mm  
For stool L 420 m  
Chromed or painted*



# ATTACCHI-PIASTRE

## JOINTS - PLATES

### Piastra OMS *Plate OMS*

Con leva e senza leva  
Cromata o verniciata  
Interasse fori 150x150 mm  
Spatola disponibile in colore nero  
- bianco - grigio

*With lever and without lever  
Chromed or painted  
Interaxis holes 150x150 mm  
Paddle available in black - white  
- grey colour*

Optional: piastra inclinata 3°

*Optional: with 3° inclination*



### Piastra Contract *Plate Contract*

Piastra 250x250 sp. 5 mm -  
Cromata o verniciata

*Plate 250x250 th. 5 mm -  
Chromed or painted*

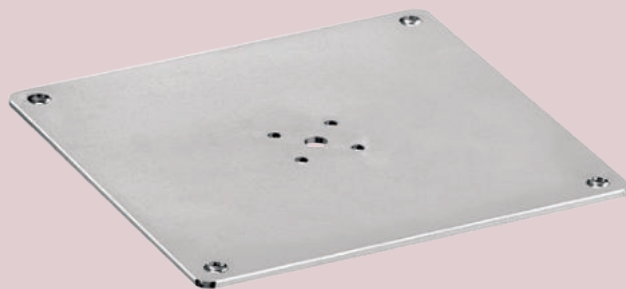

### Piastra Dover *Plate Dover*

165x165mm  
Cromata o verniciata  
Interasse fori 145x145 mm

*165x165mm  
Chromed or painted  
Interaxis holes 145x145 mm*

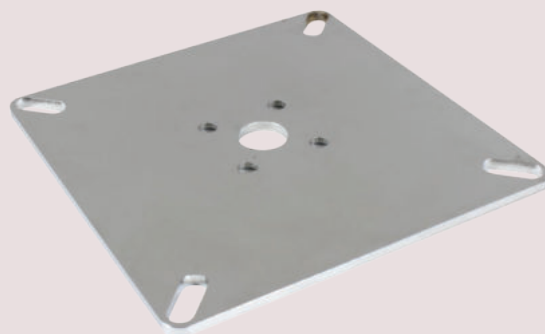

### Piastra Dover con perno girevole *Plate Dover with swivel pivot*

165x165mm - con perno Ø 28  
mm saldato  
interasse fori 145x145 mm  
Cromata

*165x165mm - with welded pivot  
Ø 28 mm  
interaxis 145x145 mm  
Chromed*





Piastra Dover con blocchetto estetico  
*Plate Dover with aesthetical join*

Piastra Dover 165x165  
Con blocchetto estetico d.50 mm  
o d.60 mm  
Con leva per alzate a gas  
Cromata o verniciata

*Plate Dover 165x165  
With aesthetical join d.50 mm or  
d.60 mm  
With lever for gaslifts  
Chromed or painted*



Piastra Dover con blocchetto conico  
*Plate Dover with conic join*

Piastra Dover 165x165 cromata o  
verniciata  
Con blocchetto conico d.50 mm  
con o senza leva,  
cromato o verniciato  
Per alzate a gas o colonne  
girevoli

*Plate Dover 165x165 chromed or  
painted  
With conic join d.50 mm with or  
without lever,  
chromed or painted  
For gaslifts or swivel columns*

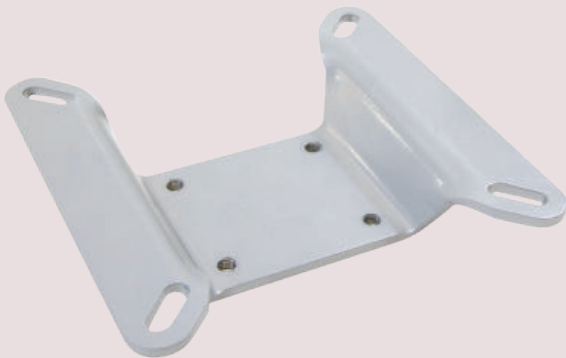

Piastra Dover attacco panca  
*Plate Dover for bench*

Piastra Dover per attacco panca  
Senza inclinazione  
Interasse 150x150 mm  
Cromata o verniciata

*Plate Dover for bench  
Without inclination  
Interaxis holes 150x150 mm  
Chromed or painted*



Blocchetto girevole  
*Swivel Join*

d.60 h.66 mm in avp con foro  
conico interno attacco d.28  
e 4 fori M6 per piastra Dover  
(interasse fori 33x33 mm)  
Cromato o verniciato

*d.60 h.66 mm in avp with a conic  
hole  
for d.28 and 4 holes M6 for  
Dover plate  
(interaxis distance 33x33 mm)  
Chromed or painted*

Piastra inox d.25  
*Inox plate D.25*

Piastra Inox 304  
d.25 mm per incollaggio  
a piano in vetro  
h. 10 mm  
1 foro M6

*Inox plate Aisi 304  
D 25 mm to be glued  
to the glass tops  
H 10 mm  
1 hole M6*



Piastra inox d.100  
*Inox plate D.100*

Piastra Inox 304  
d.100 mm per incollaggio  
a piano in vetro  
H. 10 mm  
4 fori M8

*Inox plate Aisi 304  
d.100 mm to be glued  
to the glass tops  
H. 10 mm  
4 holes M8*

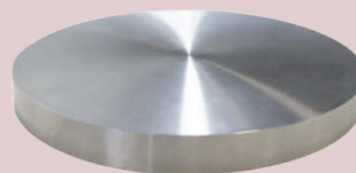

Piastra Perseo per tavolo monogamba ribaltabile  
*Perseo plate for one leg table flip-open*

Piastra sp.4 mm  
Attacco standard per tutte le  
colonne di nostra produzione  
tonde o quadre  
Cromata

*Plate thickness 4 mm  
Standard join for all our standard  
round / square columns  
Chromed*

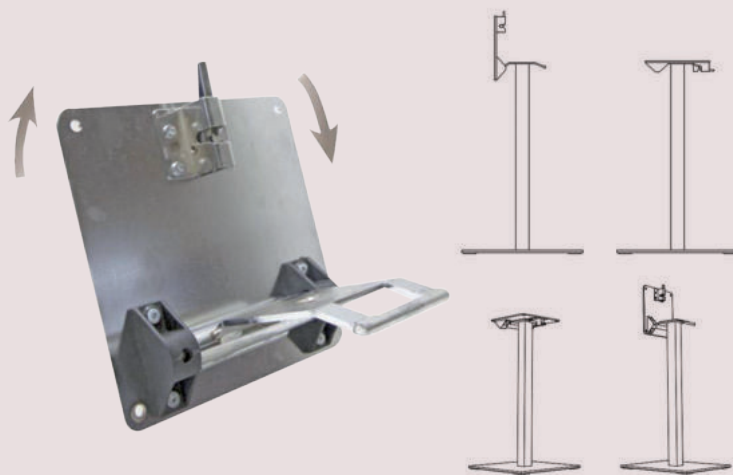

Crociera  
*Black Cast Iron Plate*

In ghisa nera Ø 450 mm,  
420x420 mm  
per tubi Ø 60 – 90 mm

*Black cast iron Ø 450 mm,  
420 x 420 mm,  
pipe diameter 60-90 mm*



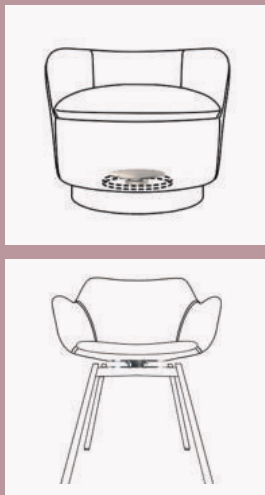

## Piastra Star per poltrone pesanti *Star Plate for heavy armchairs*

Piastra doppia mod. STAR, cromata,  
girevole 360°

*Double plate mod. STAR ,  
chromed, swivel 360 °*

### **Opzione 1)**

Piastra superiore e inferiore d.230 sp.  
5 mm, cromata  
Meccanismo centrale girevole, zincato

### **Option 1)**

*Upper and bottom plate d.230  
mm th.5 mm , chromed  
Galvanized mechanism*

### **Opzione 2)**

Piastra superiore d.230 sp.5 mm e  
piastra inferiore d.100 sp.15 mm,  
cromata  
Meccanismo centrale girevole, zincato  
Per basi Lido / Murano

### **Option 2)**

*Upper plate d.230 mm th.5 mm  
and bottom plate d.100 th.15  
mm, chromed  
Galvanized mechanism  
For Lido / Murano bases*

Portata: 250 kg

*Capacity: 250 kg*



## Piastra doppia *Double plate*

Piastra doppia 174x174x28 mm  
con autoritorno 180°, grezza,  
portata 225 kg

*Double plate 174x174x28 mm,  
with self-turning mechanism  
180°, raw, 225 kg capacity*

Piastra doppia 175x175x25  
senza autoritorno, grezza,  
portata 225 kg

*Double plate 175x175x25 without  
self-turning mechanism,  
raw, 225 kg capacity*

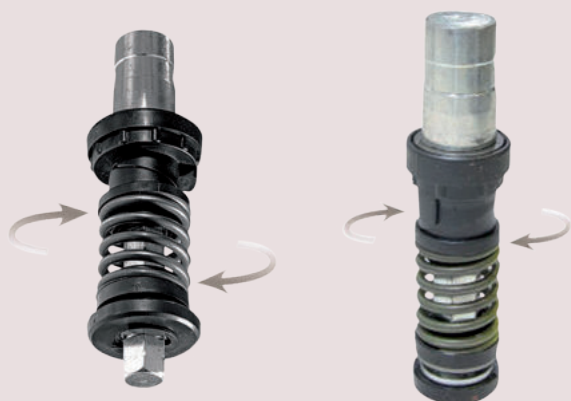

## Meccanismo Toma *Self-turning Mechanism*

Conico d. 28 mm  
Per tubo d. 50 x 1.5 mm  
Per tubo d. 40 x 2 mm  
Per tubo d. 50 x 2 mm

*Conic Ø 28 mm  
tube Ø 50 x 1,5 mm  
tube Ø 40 x 2 mm  
tube d. 50 x 2 mm*

Versione speciale su cuscinetto e  
colonna apposita su richiesta

*Special version on bearing and  
customized column on demand*



## Supporto Ischia per gambe in legno *Ischia frame for wooden legs*

Telaio per gambe in legno in tubo  
d.50x1.5 mm verniciato standard  
Con perno girevole , con  
autoallineante, con o senza  
piastra Oms 170x170  
Con piastra Dover 165x165  
cromata e girevole

*Frame for wooden legs in tube  
d.50x1.5 mm painted  
With swivel pivot , with self-  
turning mechanism , with or  
without Oms plate 170x170  
With Dover plate 165x165  
chromed and swivel*

### **Optional**

Gambe in legno faggio naturale o  
tinto noce

### **Optional**

*Natural beechwooden legs or  
painted in nut colour*

# ALTRI COMPONENTI OTHER COMPONENTS

## Bracciolo Gold *Armrest Gold*

Lama da 40x8 mm - cromato -  
Interasse fori 135 mm

*Drawn steel 40x8 mm - chromed  
- Interaxis holes 135 mm*



## Bracciolo Millennium *Armrest Millennium*

Tubo ellittico 40x20 mm -  
cromato - Interasse fori 270 mm

*Elliptical tube 40x20 mm -  
chromed - Interaxis holes 270  
mm*



## Bracciolo Anemone *Armrest Anemone*

Trafilato 40x5 mm - cromato -  
Interasse fori 220 mm

*Drawn steel 40x5 mm - chromed  
- Interaxis holes 220 mm*



## Bracciolo Apollo *Armrest Apollo*

Trafilato 50x4 mm - cromato -  
Interasse fori 235 mm

*Drawn steel 50x4 mm -  
chromed - Interaxis holes 235  
mm*





Bracciolo Rapsodia  
*Armrest Rapsodia*

Tubo ellittico 40x20 mm -  
cromato - Interasse fori 265 mm

*Elliptical tube 40x20 mm -  
chromed - Interaxis holes 265 mm*

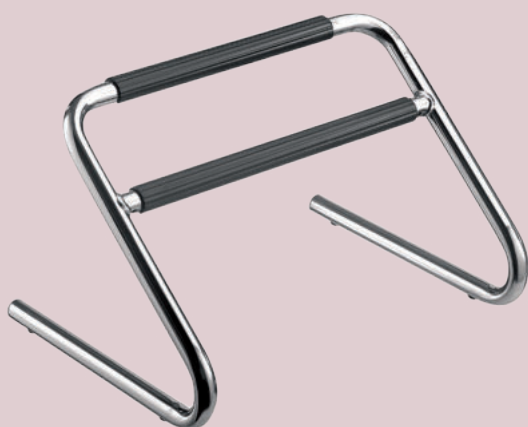

Poggiapiedi Valencia  
*Footrest Valencia*

Tubo da Ø 22 mm cromato

*Tube Ø 22 mm chromed*



Gamba Universal  
*Conic Leg Universal*

Per mobili e imbottiti  
Gamba d.25 x 1.5 mm h.210 mm  
conica con piastra di fissaggio  
Verniciata

*For furniture and upholstery  
Conic leg d.25 x 1.5 mm h.210 mm  
with fixing plate  
Painted*

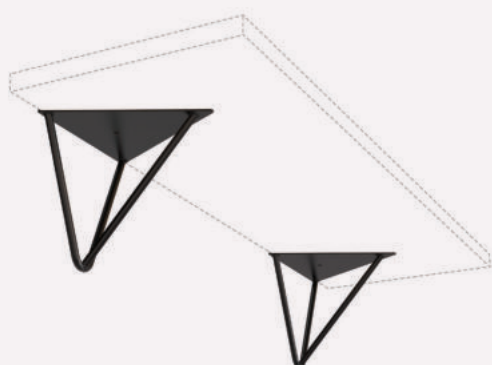

Reggimensola  
*Shelf support*

Struttura reggimensola in  
tondino d.8 mm  
Verniciata nero o bianco  
Ripiano su richiesta

*Shelf support in wire d.8 mm  
Black or white painted  
Shelf on demand*



Anelli Adattatori  
*Adaptor Rings*

d.60/50 mm  
d.50/40 mm  
60x60/50x50 mm  
50x50/d.40 mm

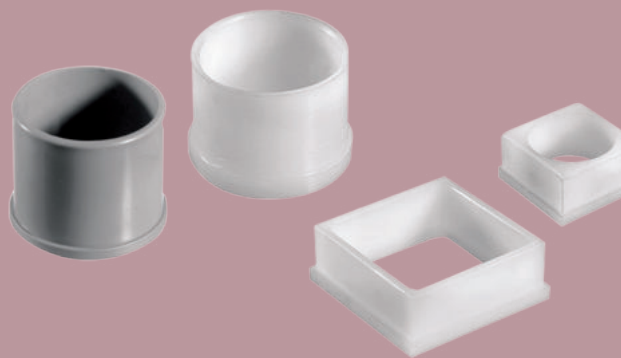

Hostaform  
*Hostaform*

BT065: d.40x2 mm  
BT030: d.50x1.5 / d.28 mm nero / black  
BT061: d.50x2 / d.28 mm nero/ black  
BT091: d.60x1.5 / d.28 mm nero/ black  
BT052: 50x50x1.5 / d.28 mm bianco / white



Feltrini a mezzaluna per basi  
*Half-moon felts for bases*

Non macchiano i pavimenti  
Per base d.390, cod. FL012:  
4 pezzi  
Per base d. 470, cod. FL007:  
3 pezzi  
Per base d. 600, cod. FL008:  
4 pezzi

*They don't stain the floor*  
*For base d.390, cod. FL012:*  
*4 pieces*  
*For base d. 470, cod. FL007:*  
*3 pieces*  
*For base d. 600, cod. FL008:*  
*4 pieces*

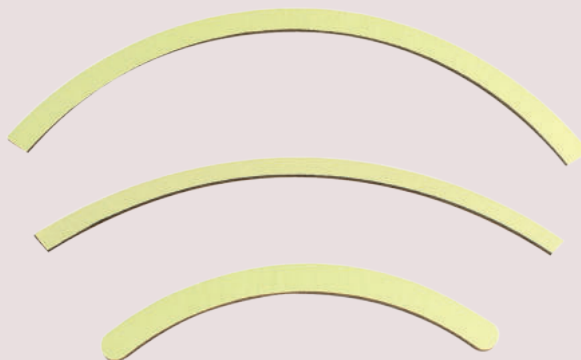

# RUOTE WHEELS

RT 009

Ruota d.50 mm, P11 in plastica nera *Wheel d.50 mm P11, black plastic nera*



RT 005

Ruota d.50 doppia con perno filettato M8 in plastica nera *Wheel d.50 mm , with pin M8 , black plastic*



RT 014

Ruota d.50 con cassa in zama effetto cromato lucido, P11x20 *Wheel d.50 in zama, chromed, P11X20*



RT 019

Ruota d.50 con cassa in zama ottonata, P 11X20 *Wheel d.50 in zama , brass colour, P 11X20*



RT 007

Ruota d.65 doppia cromata P11

*Wheel d.65 double, chromed,  
P11*



RT 017

Ruota d.60 - mod. W3 con cassa  
in zama nero, P11x20

*Wheel d.60 - mod. W3 in black  
zama, P11X20*



# SITO SITE

## Production and administrative Headquarter

Via Ca' Leoncino 52/c  
31030 Castello di Godego, TV - Italy  
Tel: +39 0423 767770 / Fax: +39 0423 768315  
info@stoccofratelli.eu

## Logistics and commercial site

Via XXIX Aprile 1  
31030 Castello di Godego, TV - Italy  
Tel: +39 0423 469939  
commerciale@stoccofratelli.eu  
sales@stoccofratelli.eu

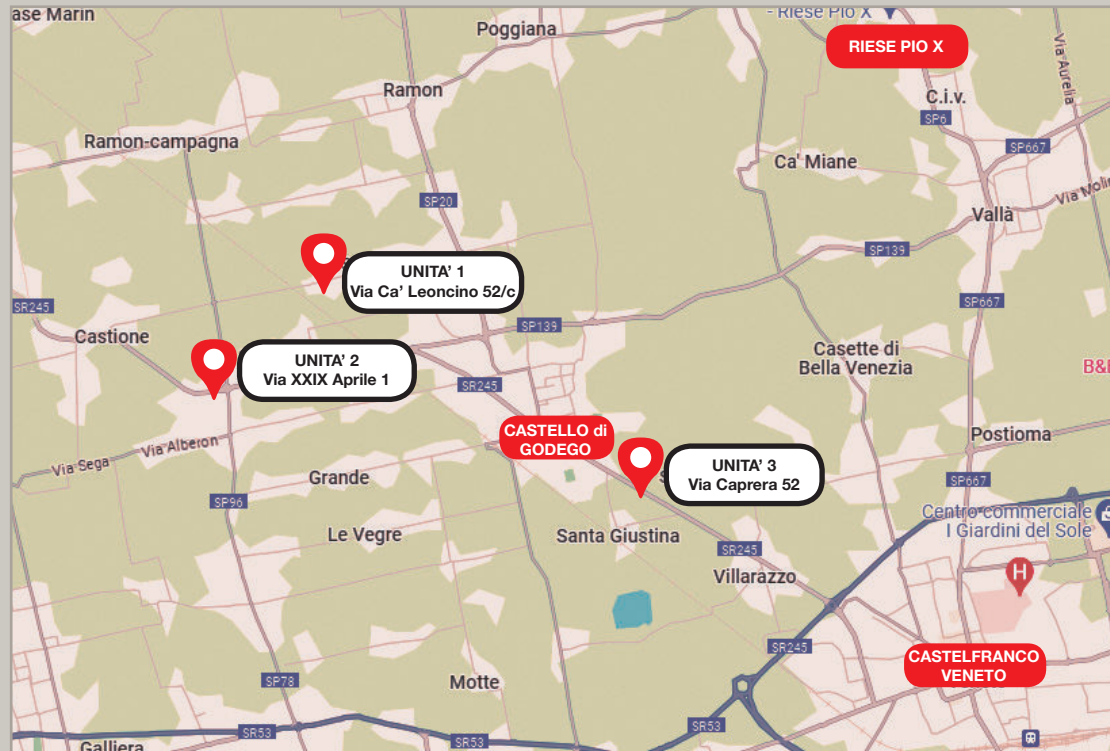

### **UNITA' 1**

- Produzione dei componenti in tubo
- Amministrazione
- Ufficio Acquisti
- Ricerca e Sviluppo

### **UNITA' 2**

- Logistica-magazzino
- Ufficio Commerciale
- Showroom

### **UNITA' 3**

- Produzione del trafilato grezzo
- Lavorazione Laser lamiera
- Saldatura robotizzata a proiezione

### **UNIT 1**

- Production of components made of tube
- Administration office
- Purchasing office
- R&D office

### **UNIT 2**

- Logistics-warehouse
- Sales office
- Showroom

### **UNIT 3**

- Production of the raw wire
- Metal sheet laser-cutting
- Robotic projection welding



**Stocco**  
F.lli srl



MADE IN ITALY



[www.stoccofratelli.eu](http://www.stoccofratelli.eu)

